



Enterprise Storage

SPC-1C Case Study

Consistent Performance

Presenter : Craig Parris (Seagate)



Storage Performance Council (SPC) is a non-profit corporation founded to define, standardize, and promote storage subsystem benchmarks .
The goal of the SPC is to serve as a catalyst for performance improvement in storage subsystems.

founded in 1998, to:Define, standardize and promote industry standard storage benchmarks.

Many Storage Industry Companies are Members

SPC Benchmark Spectrum

Large system focused benchmarks

- SPC Benchmark 1 (SPC-1)
- SPC Benchmark 1/Energy (SPC-1/E)
- SPC Benchmark 2 (SPC-2)

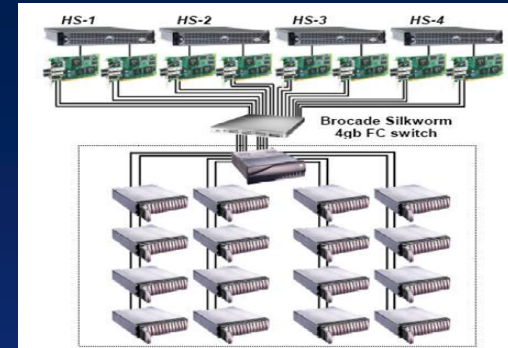

Component focused benchmarks single enclosure and below

- SPC Benchmark 1C (SPC-1C)
- SPC Benchmark 1C/Energy (SPC-1C/E)
- SPC Benchmark 2C (SPC-2C):

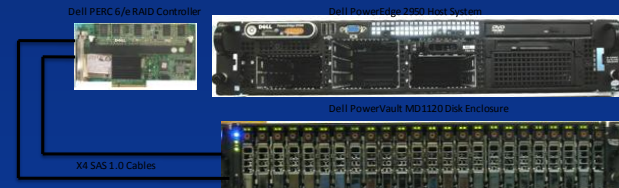

SPC-1C Benchmarks

Synthesized Realworld workloads

Platform independent

- ✓ Win200x x32/x64
- ✓ Solaris
- ✓ Linux

Interface independent SAS/FC/SATA

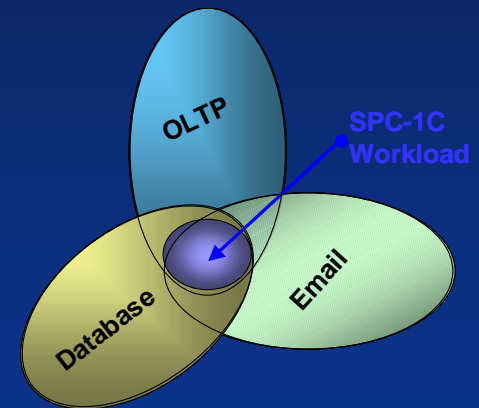

SPC-1C Benchmark

SPC-1C is comprised of a set of I/O operations designed to demonstrate the performance of a small storage subsystem while performing the typical functions of a business critical application.

SPC-1C represents a segment of applications characterized by predominately random I/O operations and requiring both queries as well as update operations (for example: OLTP systems, Database systems, or Mail Server applications).

SPC-1C focuses on Small storage configurations
The Average Response Time, for the IOPS cannot exceed 30ms

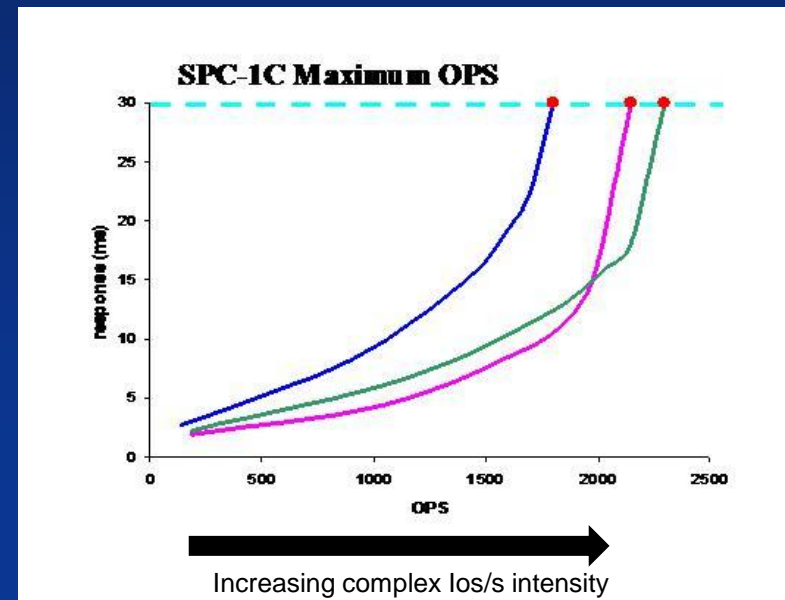
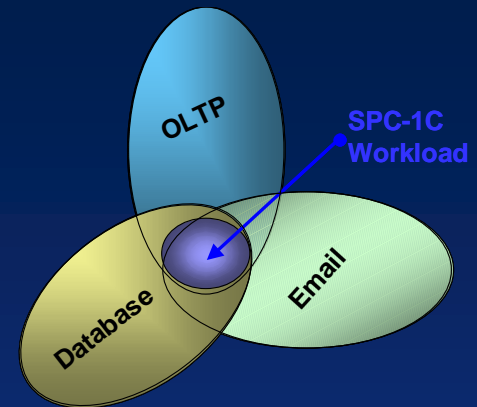
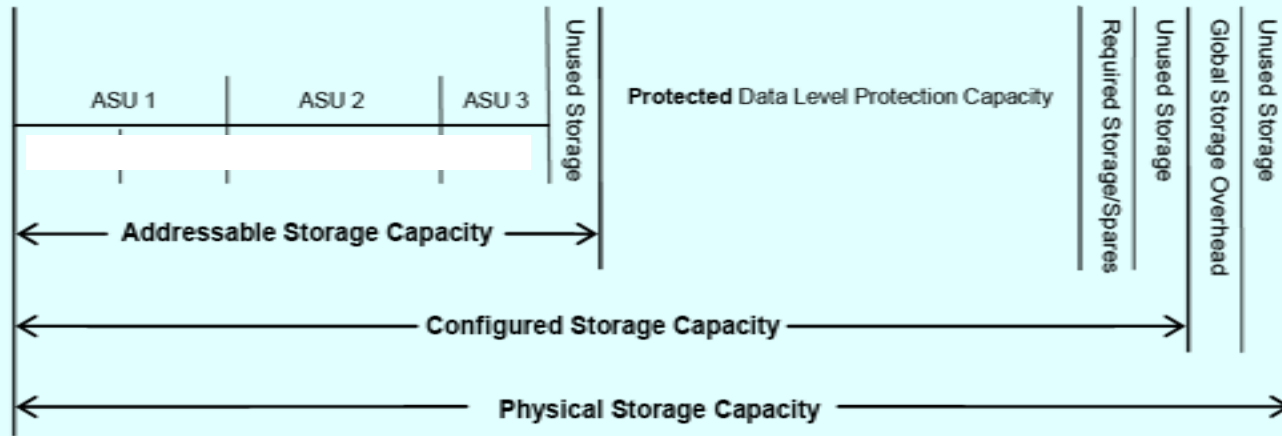

Figure 2-1: SPC-1C Storage Hierarchy



Seagate currently benchmarks
HDD with 50% of available physical capacity
SSD with 100% of available physical capacity

ASU1= 45% of capacity
ASU2= 45% of capacity
ASU3=10% of capacity

ASU= Application Storage Unit abstract term for raw partition

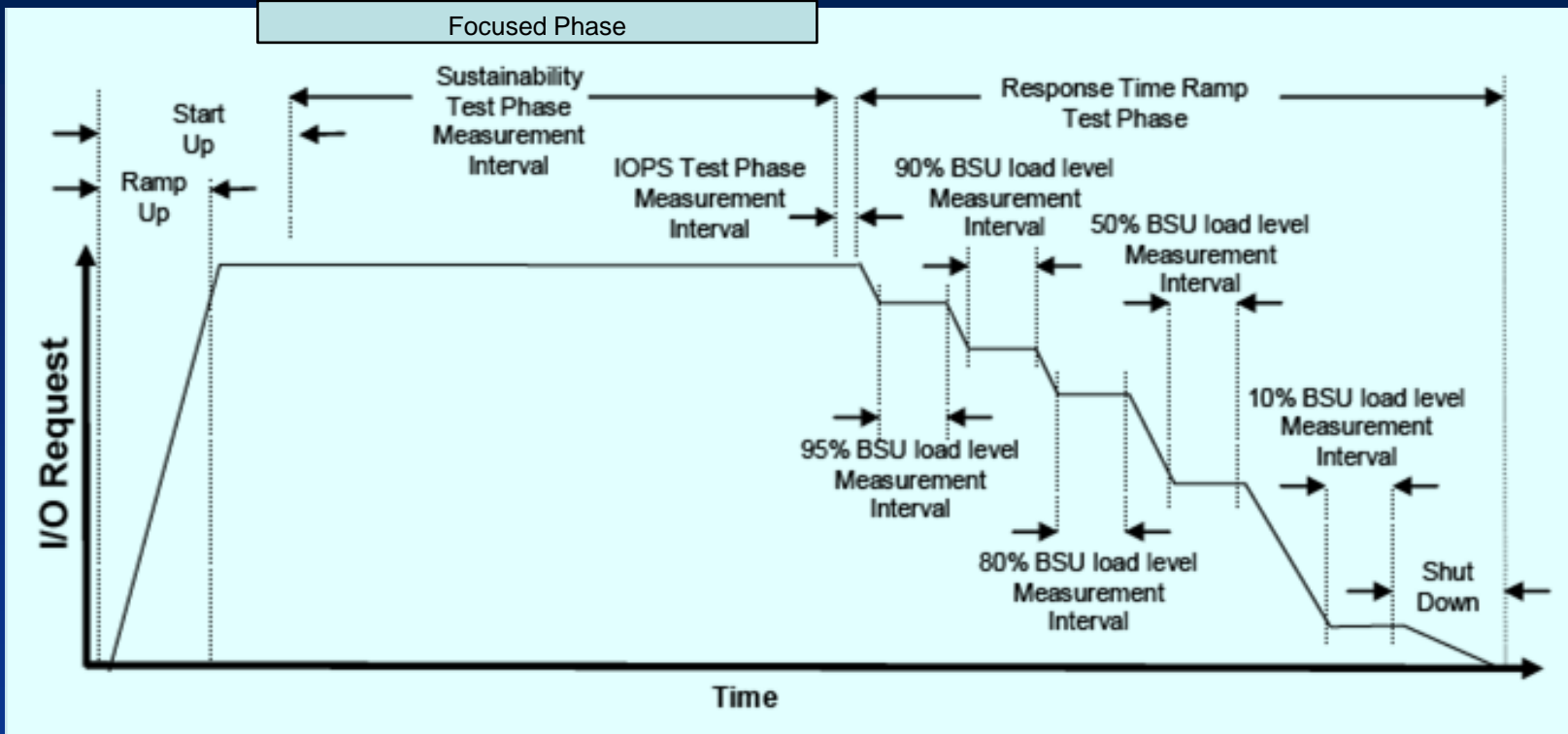



SPC-1C Accessed LBA locations

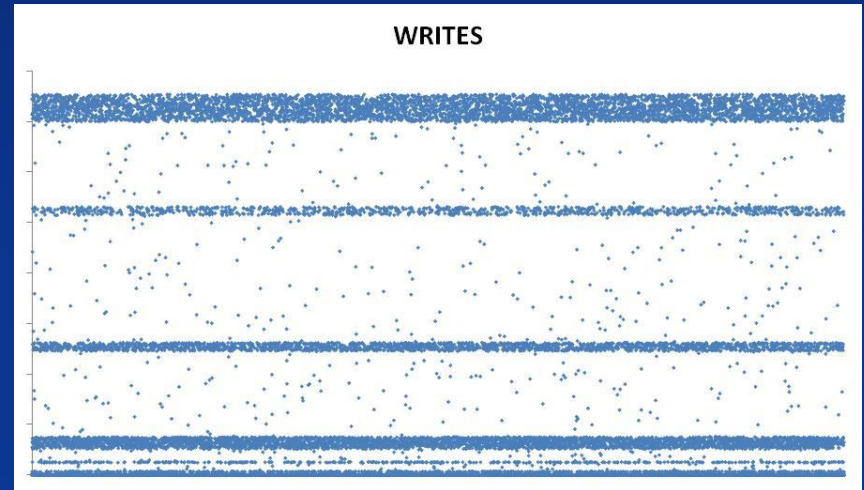
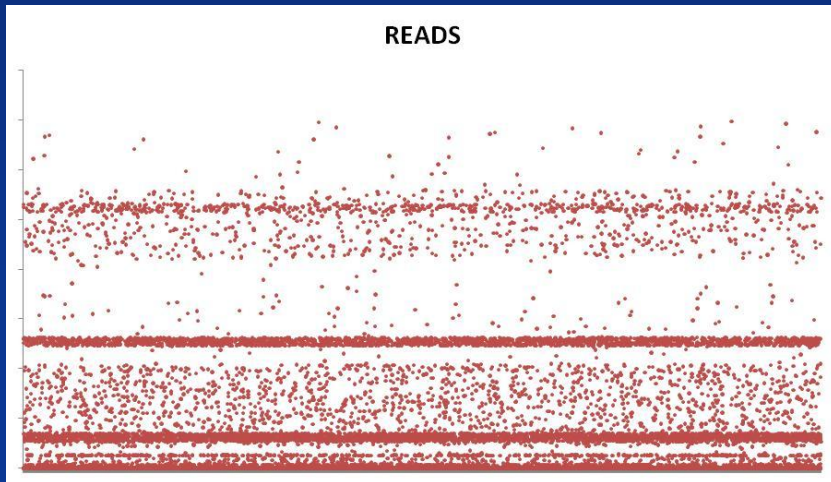
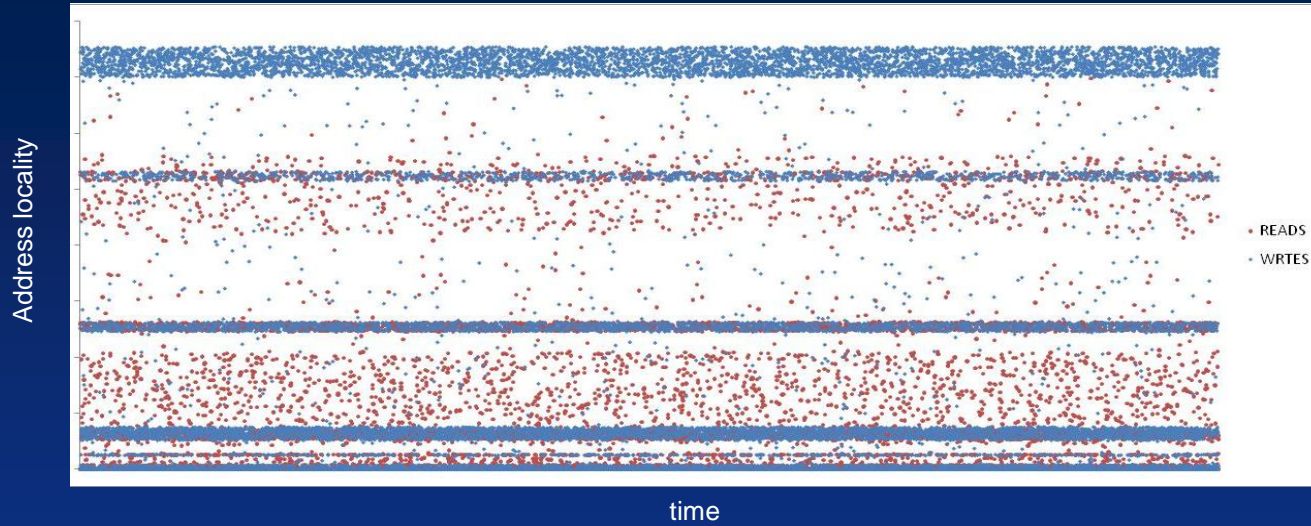

Summary of workload transfer sizes

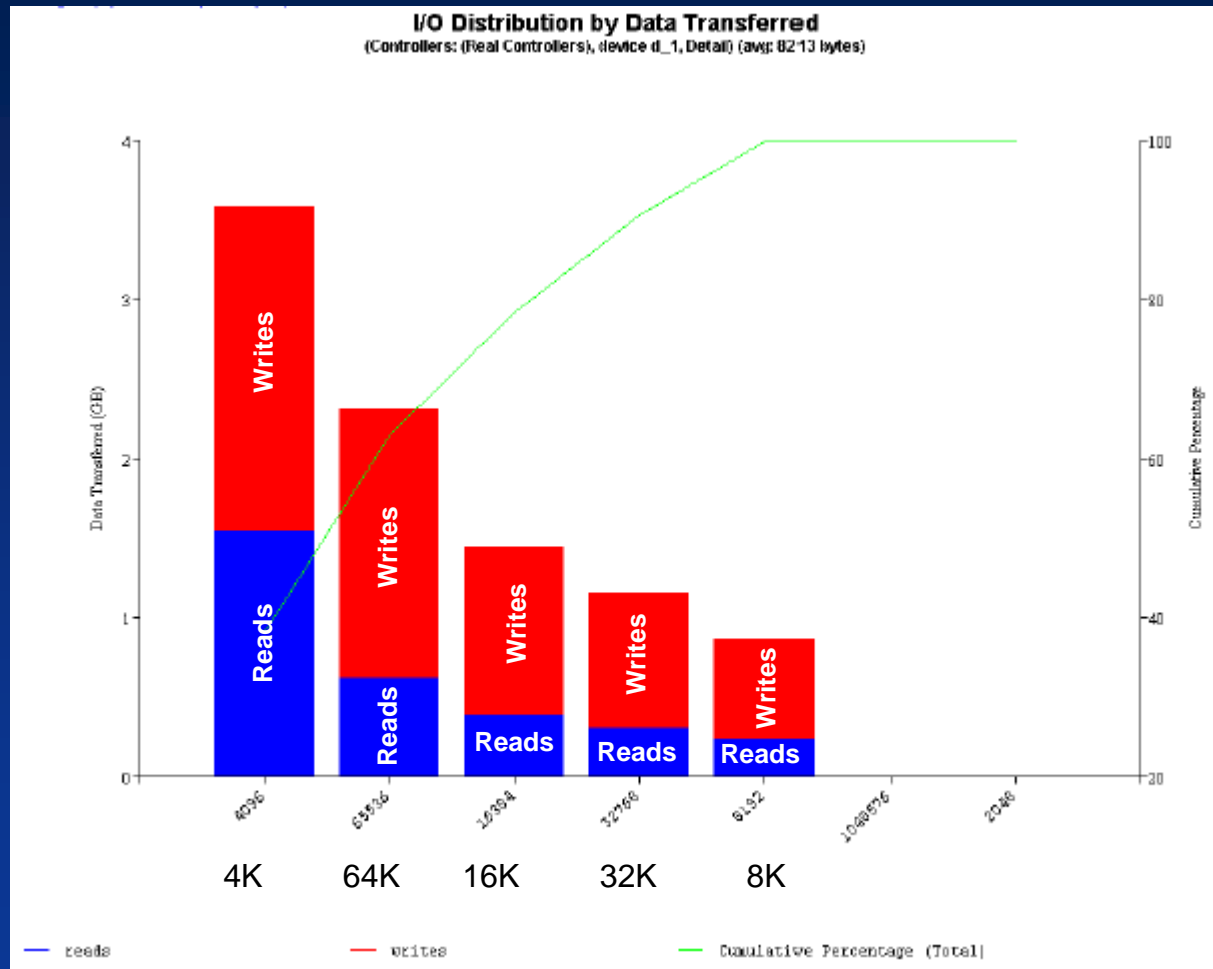

SPC-1C Accessed address space

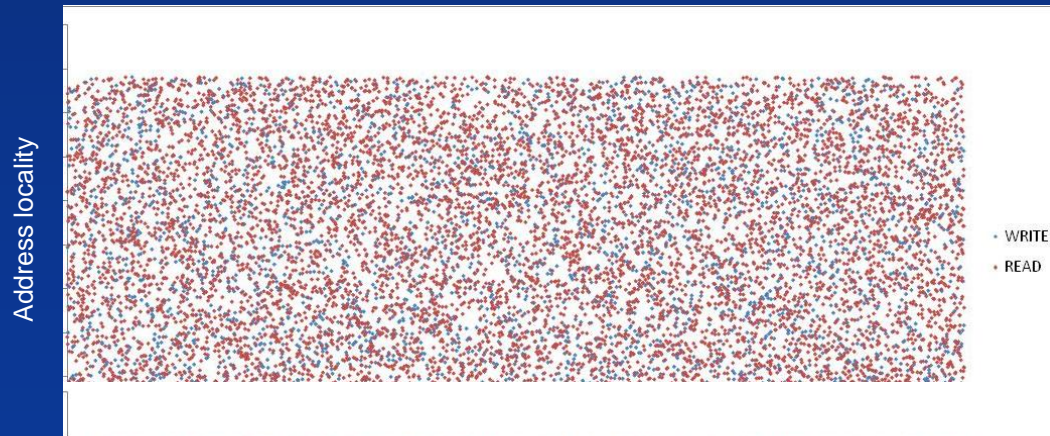
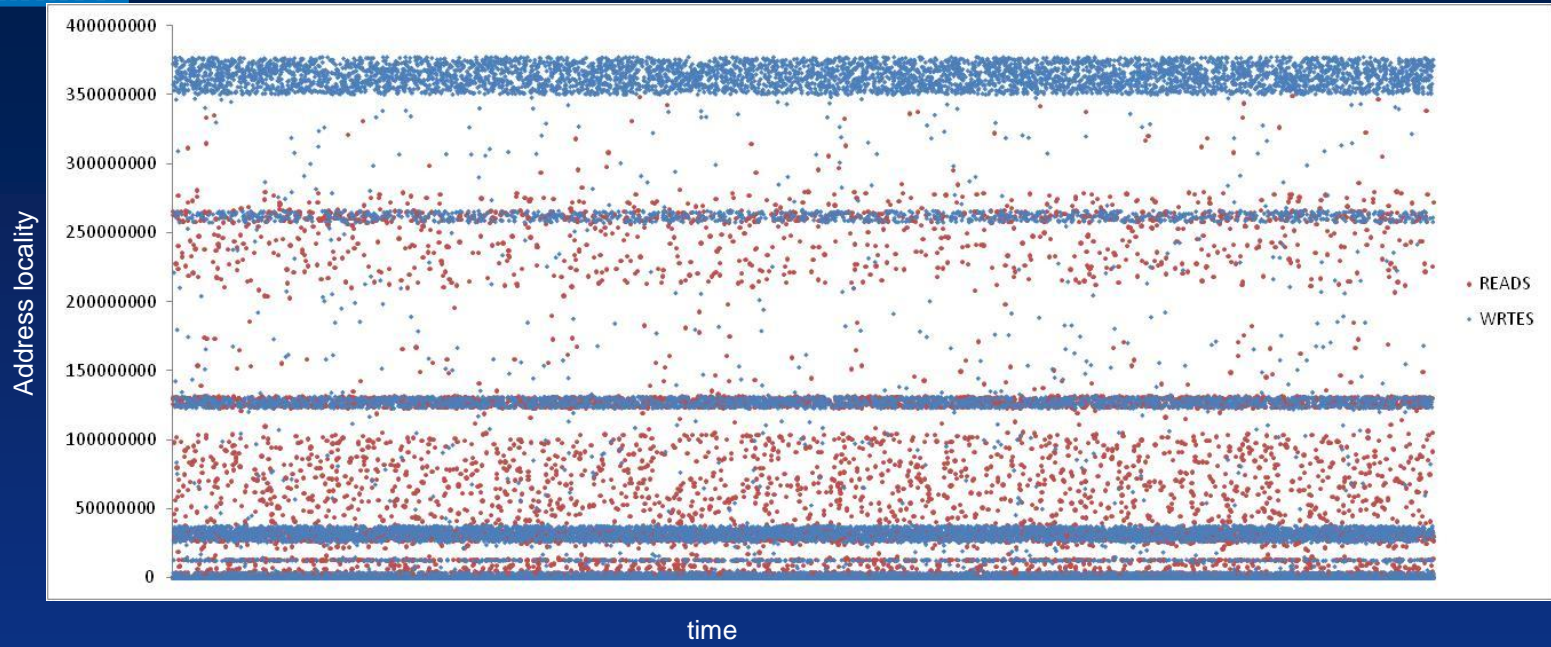

OLTP type 30/70 workload
Using Iometer or Vdbench
Over random address space

SPC-1C Example Results Snapshot

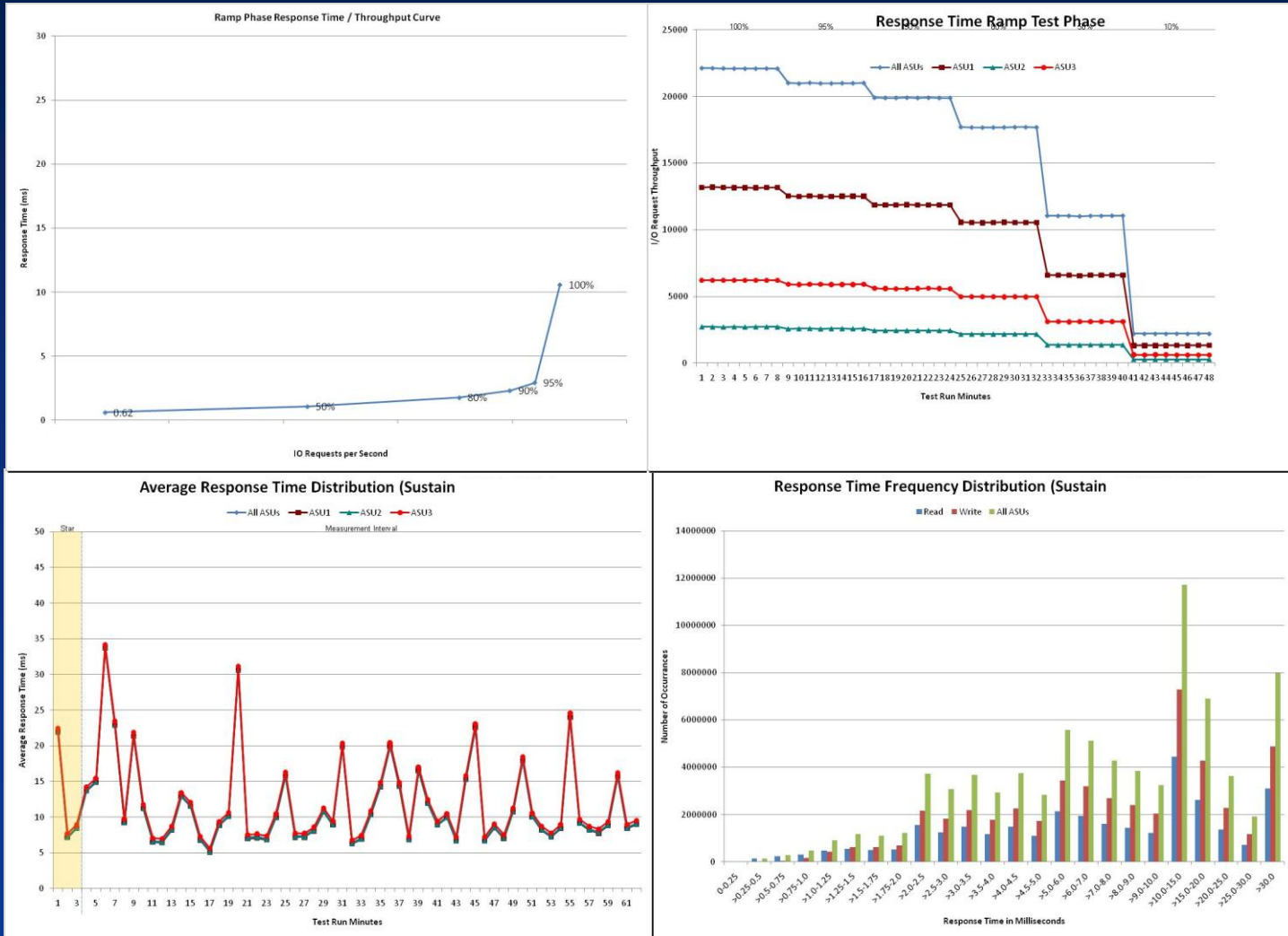

Summary Enterprise Class SSD

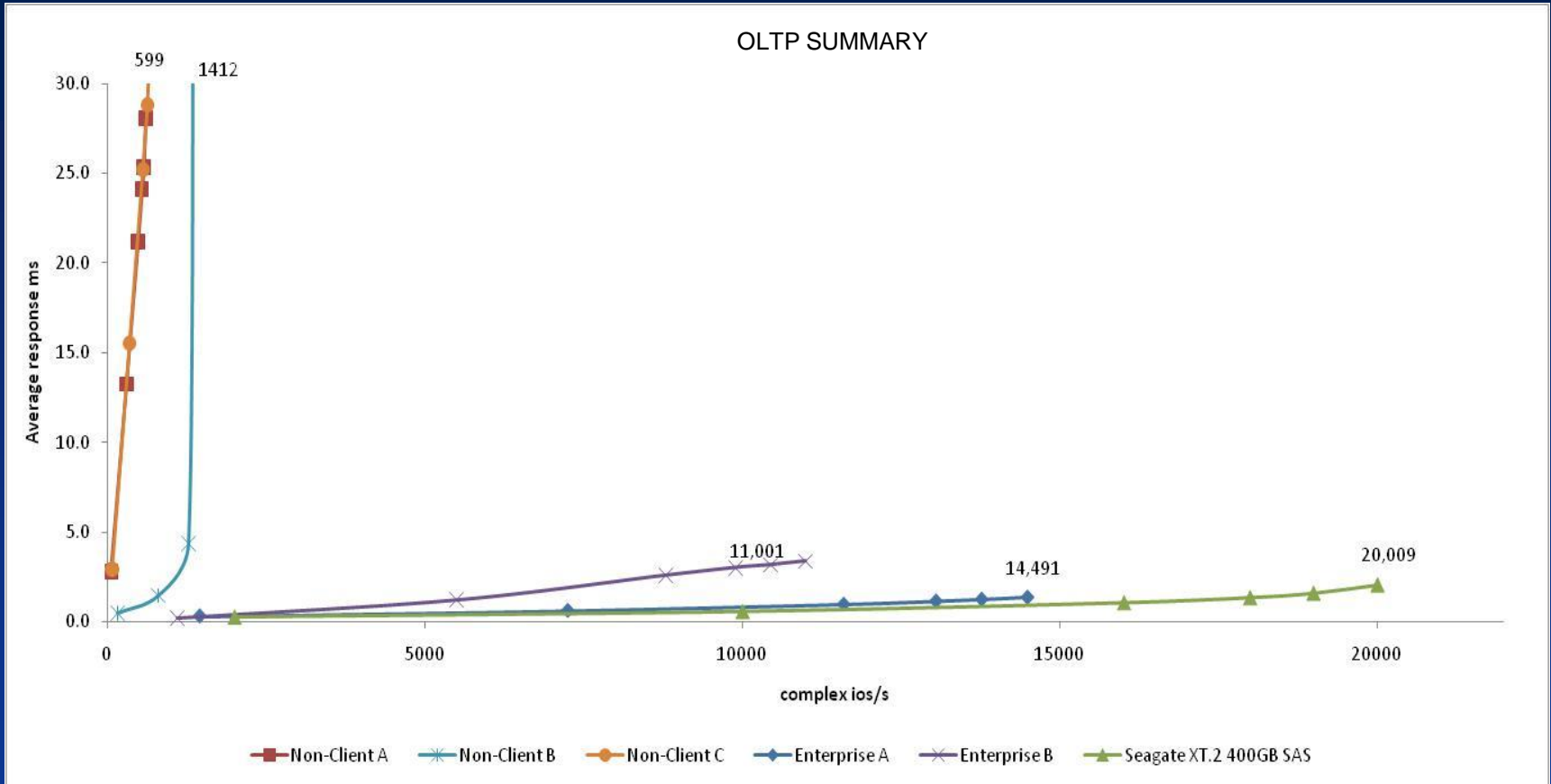

Complex workload increased to maximum device sustained capability

Sustained average response time characteristics “matter”

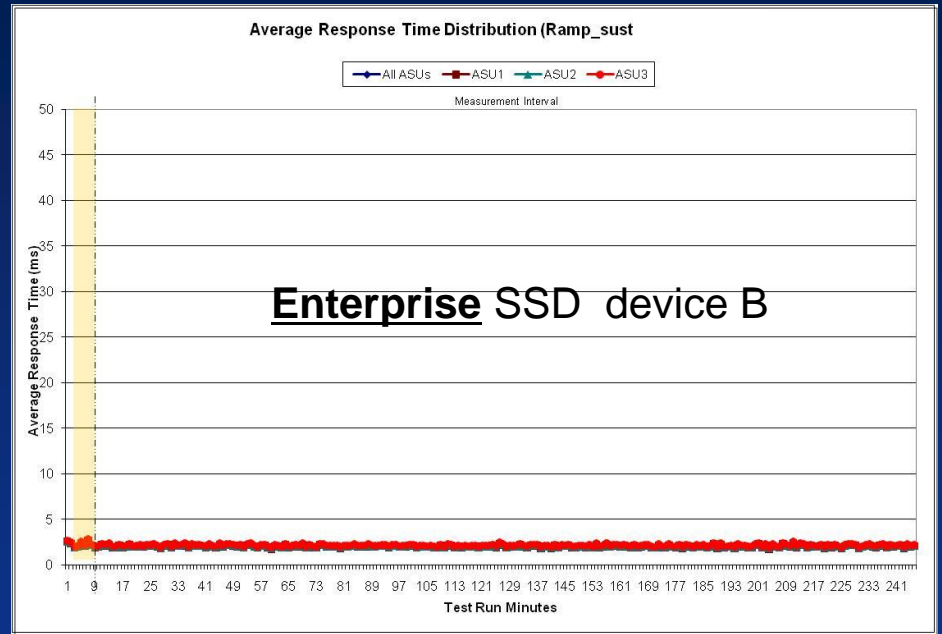
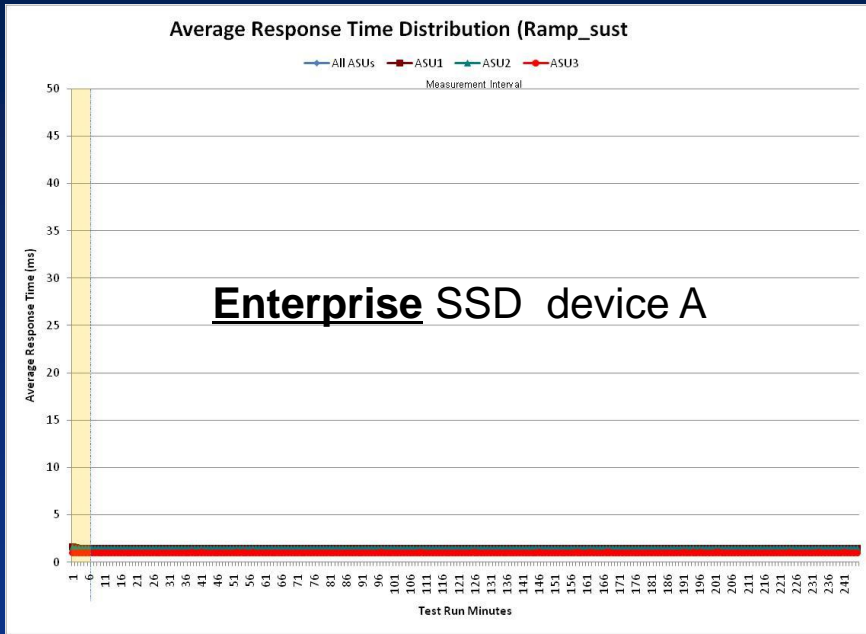

Sustained response time characteristics do matter in Enterprise

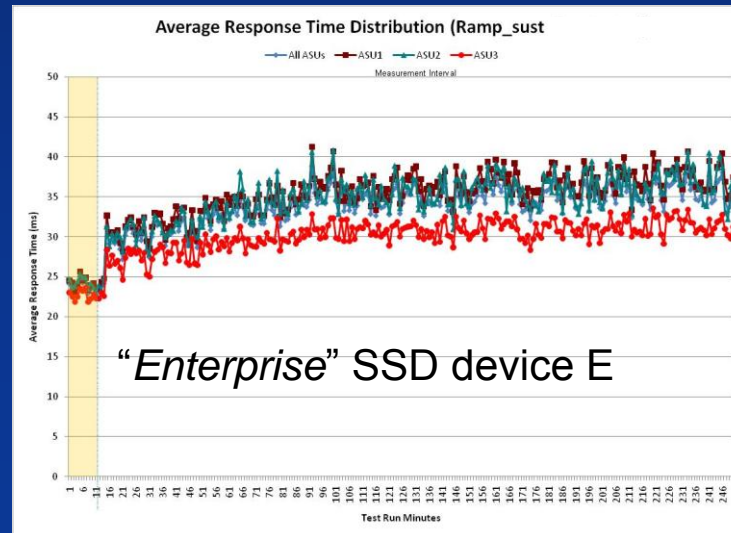
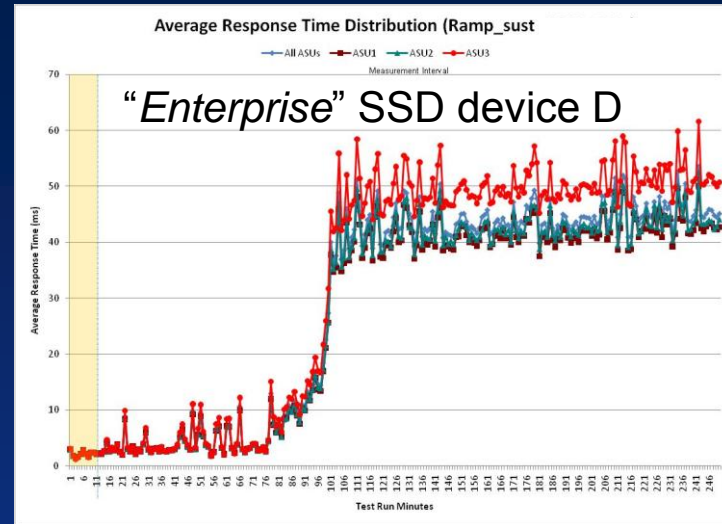
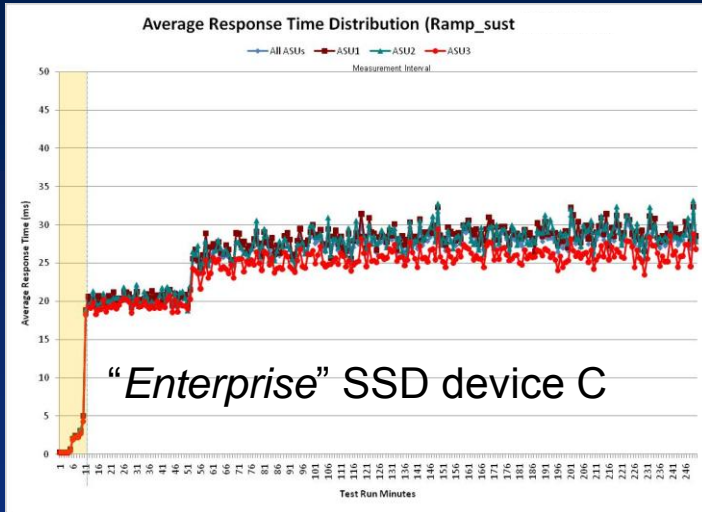

SPC tools can be used internally for product development
and externally for verified demonstration of performance

Please reference the below link for further information about SPC

<http://www.storageperformance.org>

* Details of the Seagate Pulsar XT.2 SSD SPC-1C Result can be found at:
http://www.storageperformance.org/results/benchmark_results_spc1c/#c00012

