



ACCESS WITHOUT LIMITS

Breaking Down the Barriers to PCIe SSD Adoption

Derek Dicker, VP, Performance Solutions Group



Non-Volatile Memory Changes Everything



The Ripple Effect of NVM

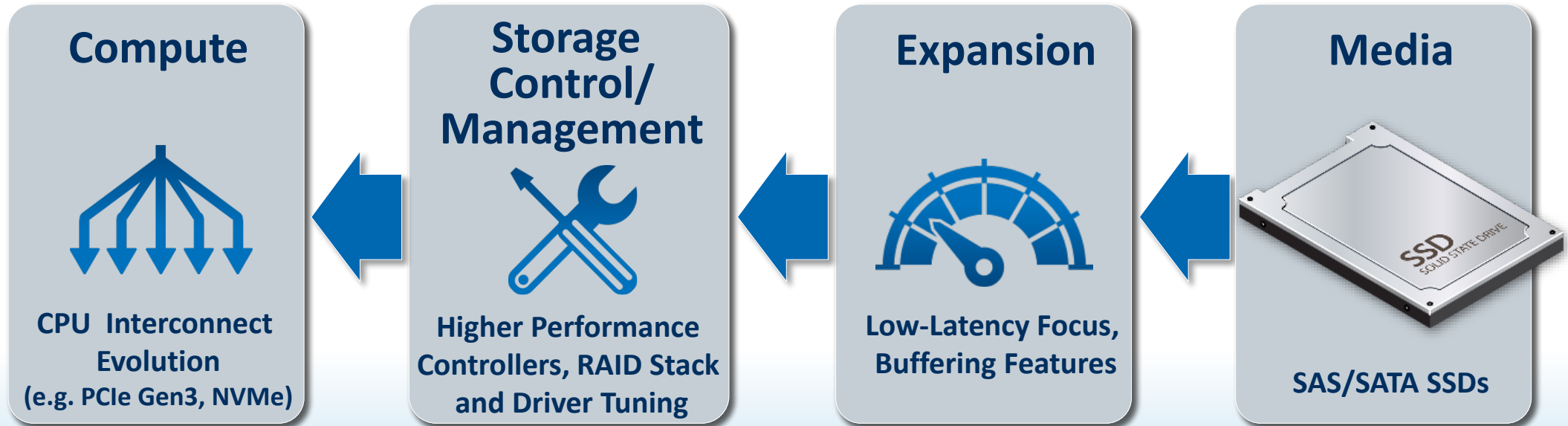

CAPACITY TIER

SAS & SATA

The Ripple Effect of NVM

THE EMERGENCE OF THE PERFORMANCE TIER

Compute

Storage
Control/
Management

Expansion

Media

PERFORMANCE TIER

PCIe

PCIe
SSDs

CAPACITY TIER

SAS & SATA

Software Defined Flash

n. /'sôft,we(ə)r -di'fined-flaSH /

An enterprise class flash solution that uses standard hardware with all the important storage and management functions performed in intelligent firmware and software to maximize the value of the flash in its environment.

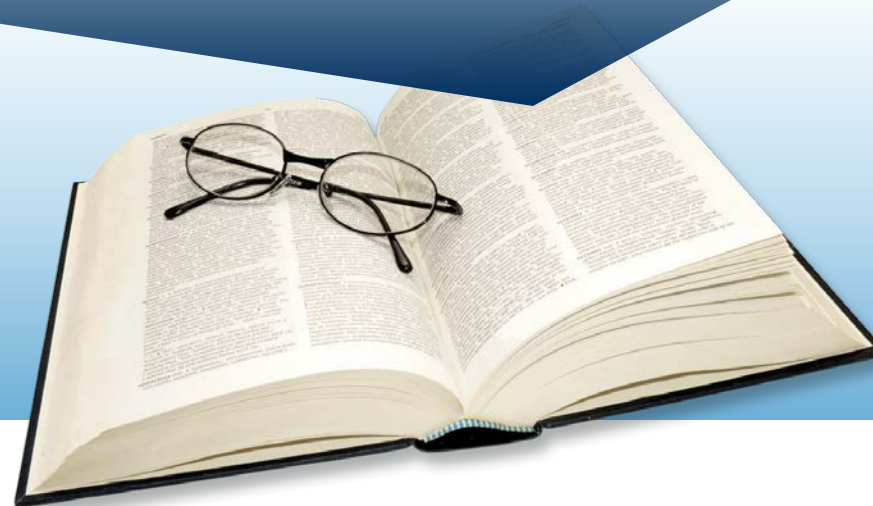

SDF Ecosystem

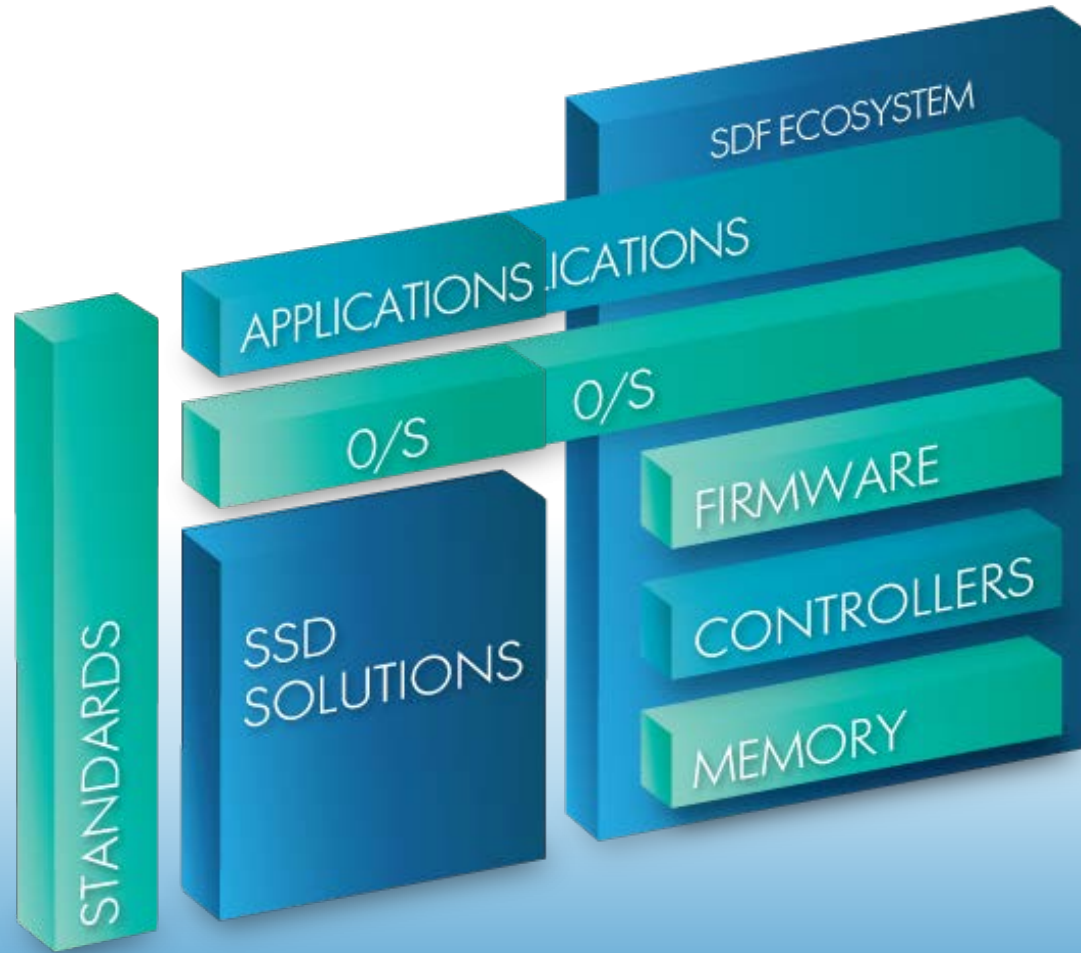

PMC SDF Controller Momentum

SOLID PROGRESS SINCE WE LAST MET

- 40+ Unique SKUs
- 5 of 6 NAND Manufacturers Used
- SLC, MLC, eMLC and TLC
- Add-In Card, 2.5", and Custom Form Factors
- Enterprise SSD, Hyperscale SSD, and All Flash Array SSD

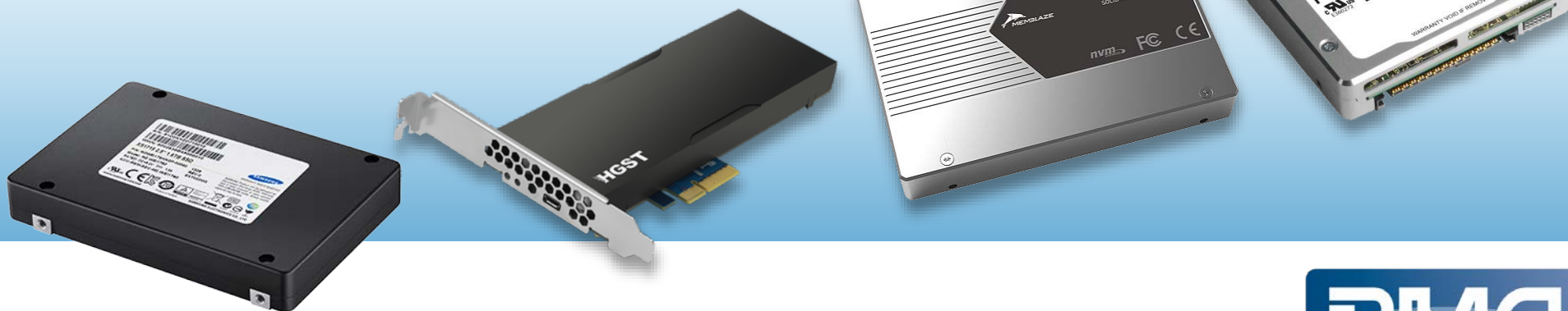

... And The Momentum Continues...



Announcing the Next Generation SDF Controller

Flashtec™ NVMe2032

- **Best-in-Class Performance: 1M IOPs!**
- **Support for Large Capacity (> 20TB)**
- **LDPC ECC Capabilities for Next Generation NAND**
 - Adaptive LDPC Support (1Y and beyond)
- **SDF-optimized Flash Interface**
 - Programmable interface allows for custom micro-commands to the NAND
 - Support for Toggle DDR 3.0, ONFI 4.0
 - Flexible architecture allows customers to differentiate their products



The Ripple Effect of NVM

Compute

Storage
Control/
Management

Expansion

Media

PERFORMANCE TIER

PCIe

PCIe
Switches



PCIe
SSDs

CAPACITY TIER

SAS & SATA

Today's PCIe Switches

...Until Now...

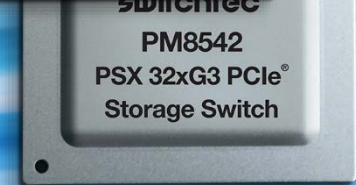

“Before”

use case: 40 SSD all Flash Array

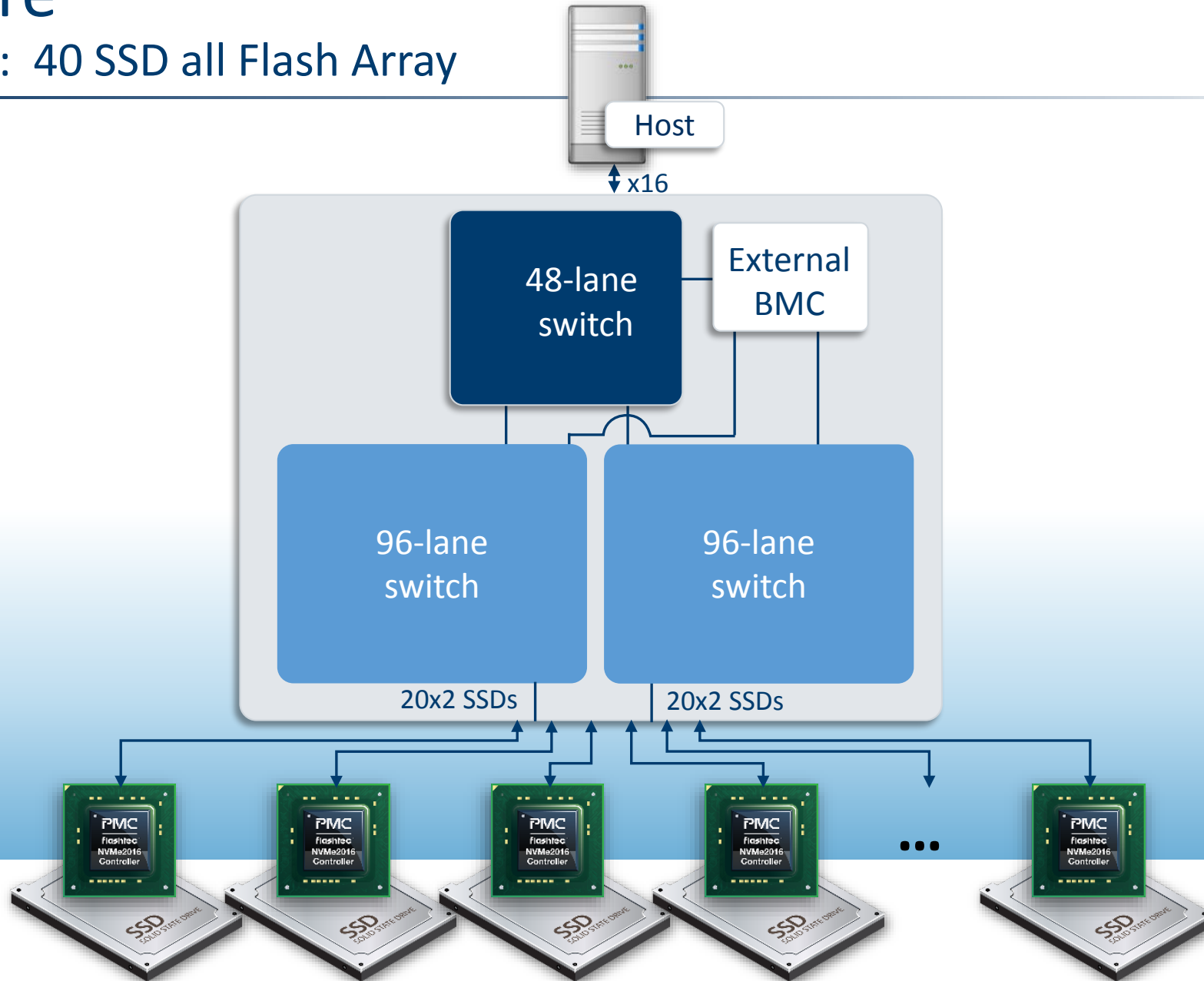

“After”

use case: 40 SSD all Flash Array

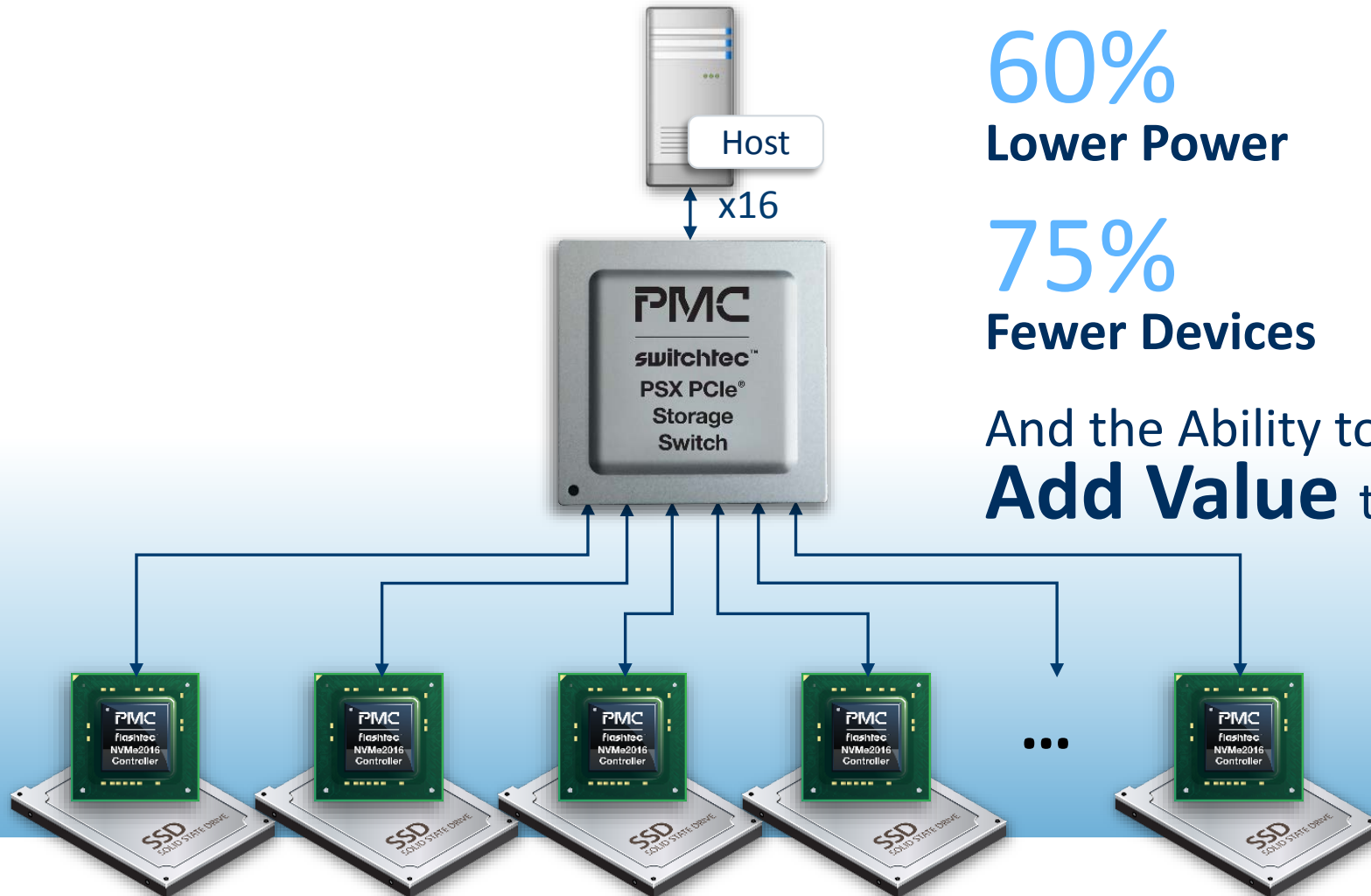

60%
Lower Power

75%
Fewer Devices

And the Ability to
Add Value through Firmware



Switchtec PSX Storage Switches

THE INDUSTRY'S FIRST SOFTWARE DEFINED STORAGE SWITCH



- **PCIe Resiliency**

- Error containment to prevent system crashes and blue-screening, hot-, surprise-plug
- Extensive diagnostics and debug

- **Flexible Port Bifurcation and Low Power**

- Flexible x2/4/8/16 port bifurcation
- Up to 60% lower power than other solutions

- **Highest Port and NTB Density**

- Up to 48 ports, 48 NTBs and 24 Virtual Switch Partitions

- **Programmable Storage Switch**

- PCIe Switch programmability
- Integrated enclosure management processor



Software Defined Switching

n. /'sɒft,we(ə)r -di'fɪned-swɪtʃ'ng /

A switching solution that uses standard hardware with all the important storage and management functions performed in intelligent firmware and software to maximize the value of the switch in its environment.

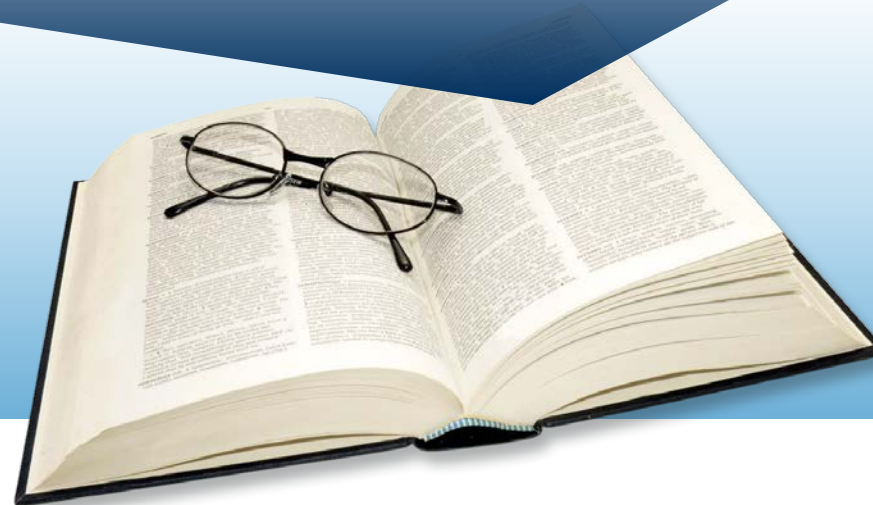

The Ripple Effect of NVM

Compute

Storage
Control/
Management

Expansion

Media

PERFORMANCE TIER

PCIe



CAPACITY TIER

SAS & SATA



Please Join Us at Booth #213

