

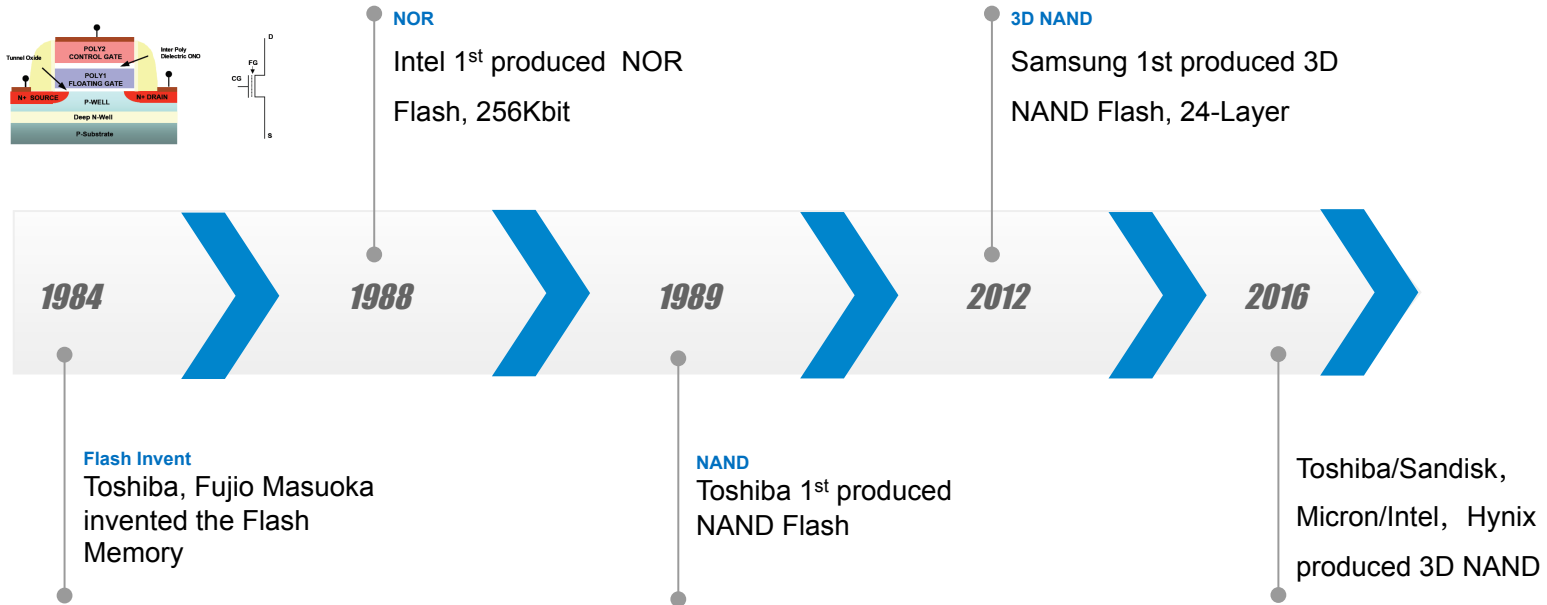

NOR Flash from Greater China : From Follower to Leader

Michael Wang, VP Strategic Marketing
GigaDevice Semiconductor Inc.

History of Flash Memory Technology





NAND vs. NOR Flash

	NAND	NOR
Cell Array		
Layout		
Cross Section		
Cell Size	4F ²	10F ²

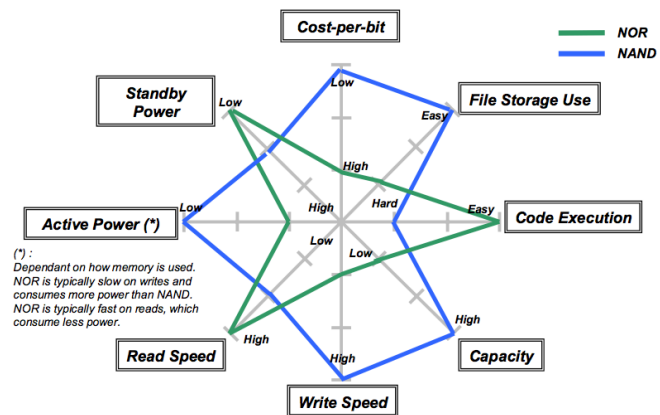

Function	Application
Data	<div style="display: flex; justify-content: space-around;"> <div style="border: 1px solid orange; padding: 5px;">USB/Cards</div> <div style="border: 1px solid orange; padding: 5px;">SSD</div> </div>
Code + Data	<div style="display: flex; justify-content: space-around;"> <div style="border: 1px solid red; padding: 5px;">Mobile</div> <div style="border: 1px solid green; padding: 5px;">DVD</div> <div style="border: 1px solid green; padding: 5px;">STB</div> <div style="border: 1px solid green; padding: 5px;">Networking</div> </div>
Code + Parameter	<div style="display: flex; justify-content: space-around;"> <div style="border: 1px solid blue; padding: 5px;">Modem</div> <div style="border: 1px solid blue; padding: 5px;">PC</div> <div style="border: 1px solid purple; padding: 5px;">Industrial</div> <div style="border: 1px solid purple; padding: 5px;">Automotive</div> </div>
Code Only	<div style="display: flex; justify-content: space-around;"> <div style="border: 1px solid blue; padding: 5px;">HDD, Add-on boards, CD-ROM</div> <div style="border: 1px solid blue; padding: 5px;">Printer, DVD, PDA, OA, Games, TV</div> </div>



NAND dominates Flash landscape, yet NOR continues finding its niche. . .

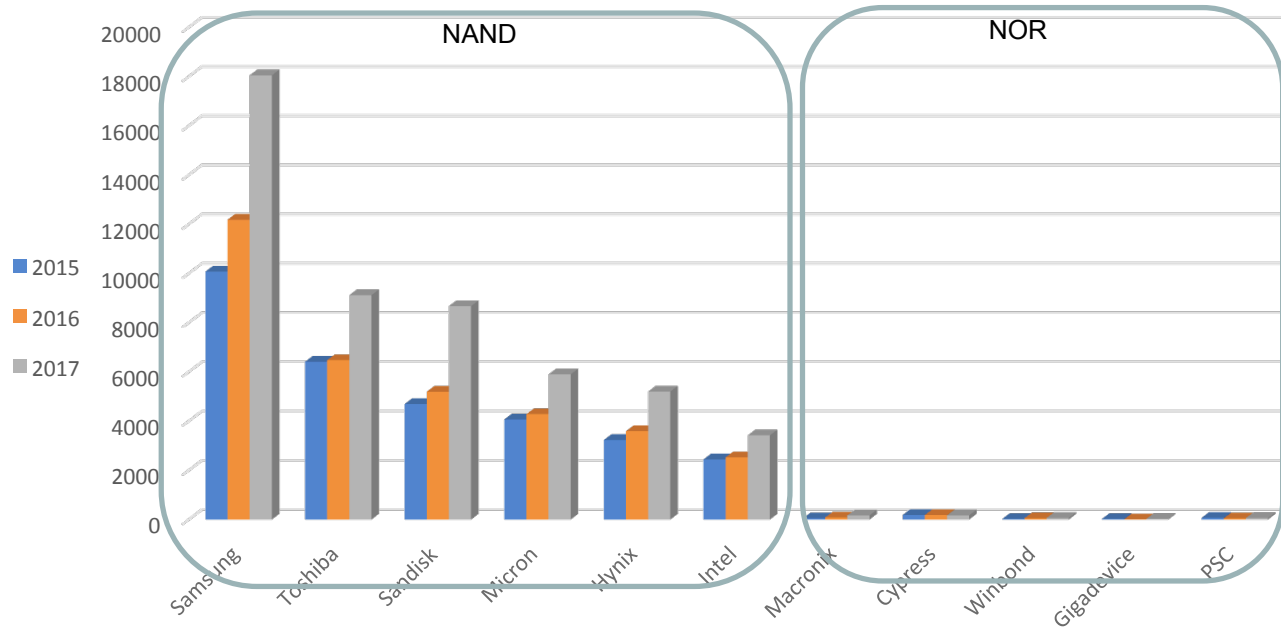



Turning around for NOR Flash Market

- Downward of traditional Market slow down in 2015
- Now we have cross “V” wave and back to ramp

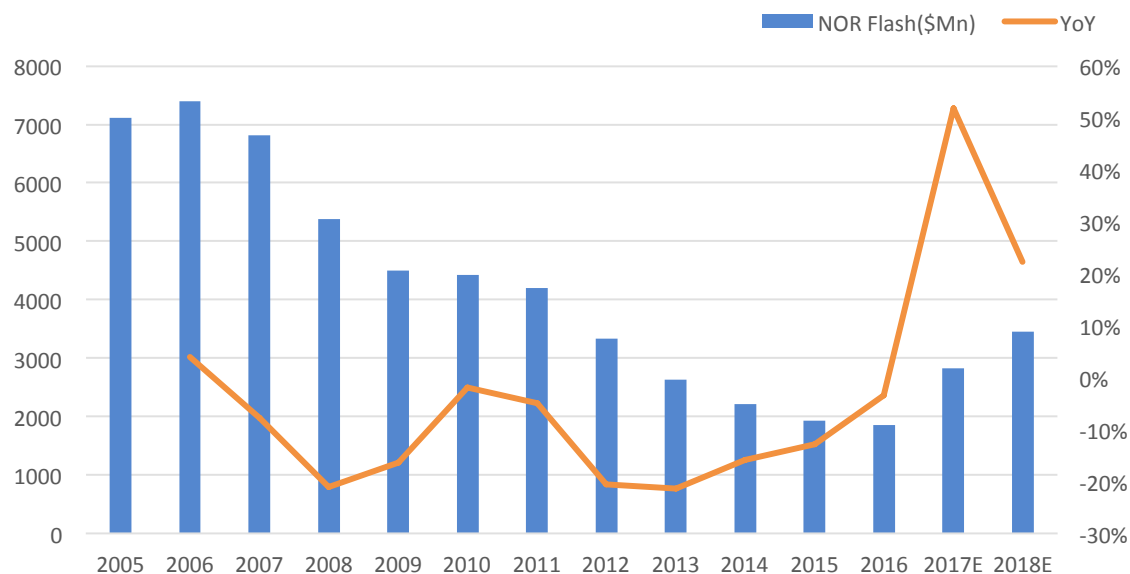

Feature Phone (-) → Embedded System IoT and Modules (+)



NOR Flash in Growing Applications

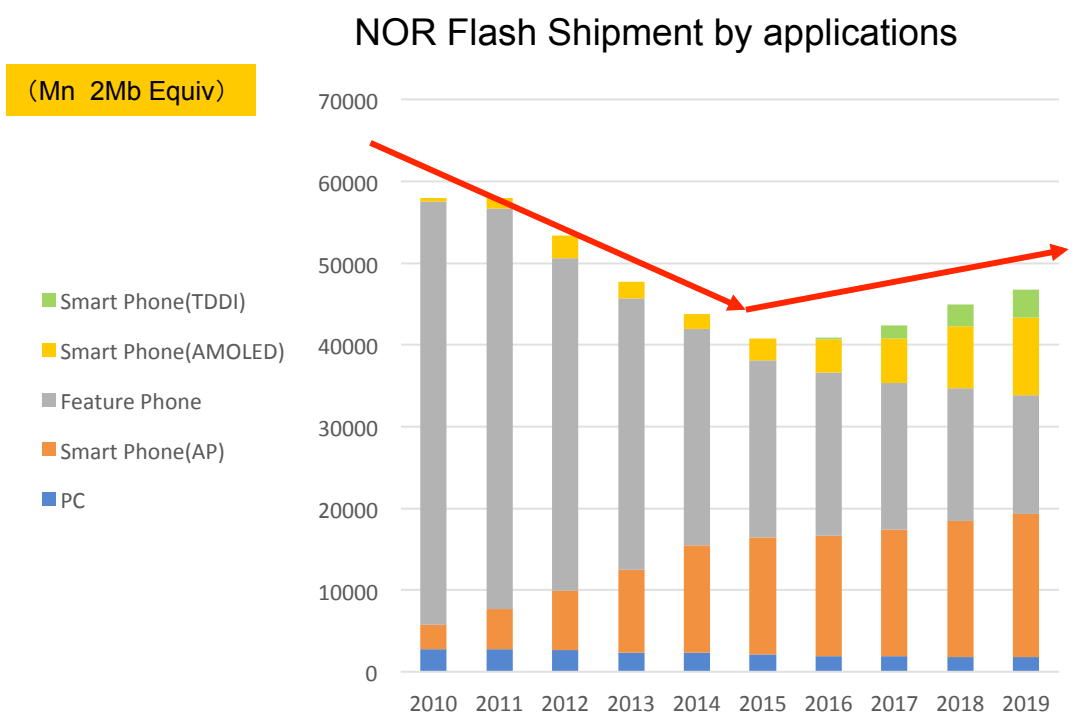



Flash Memory Summit

NOR Flash: Indispensable in every Embedded Systems

Boot code in system from shadowing to eXecution In Place

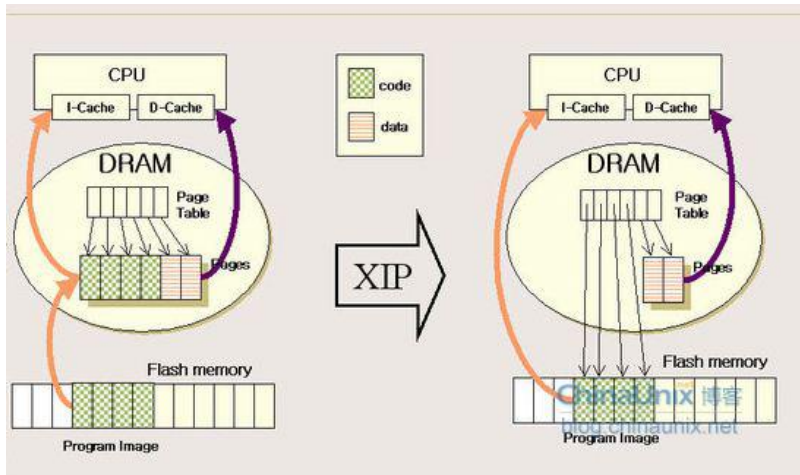

Flash Memory Summit 2018
Santa Clara, CA

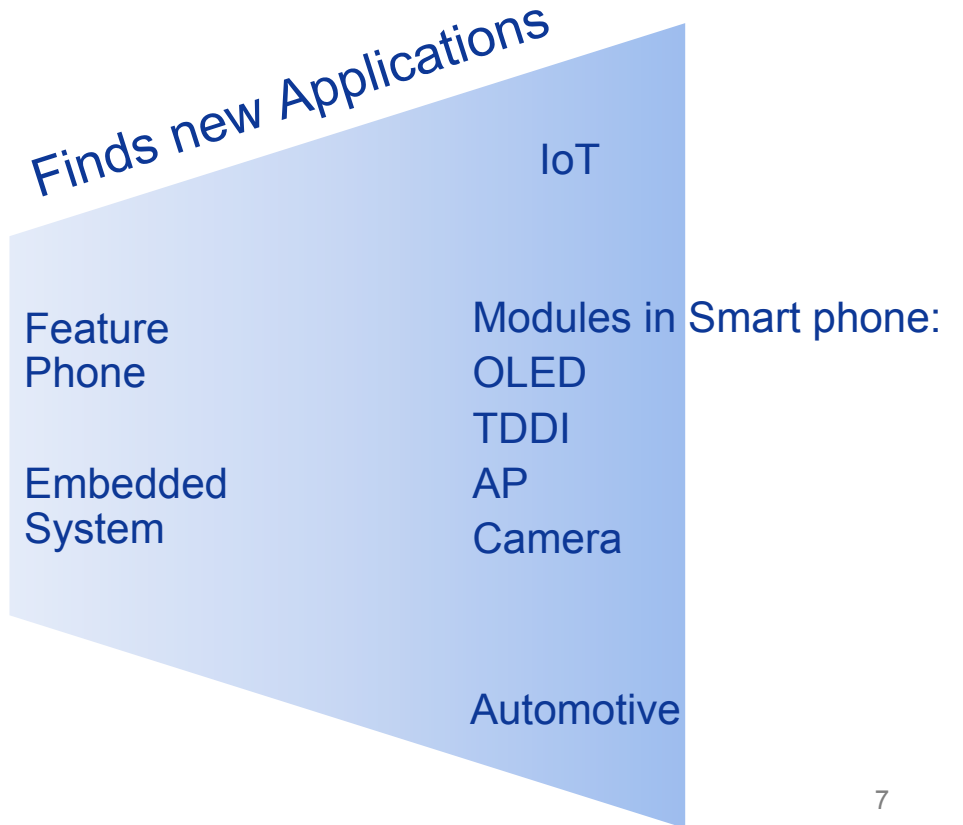

Growing Presence from Greater China NOR Suppliers

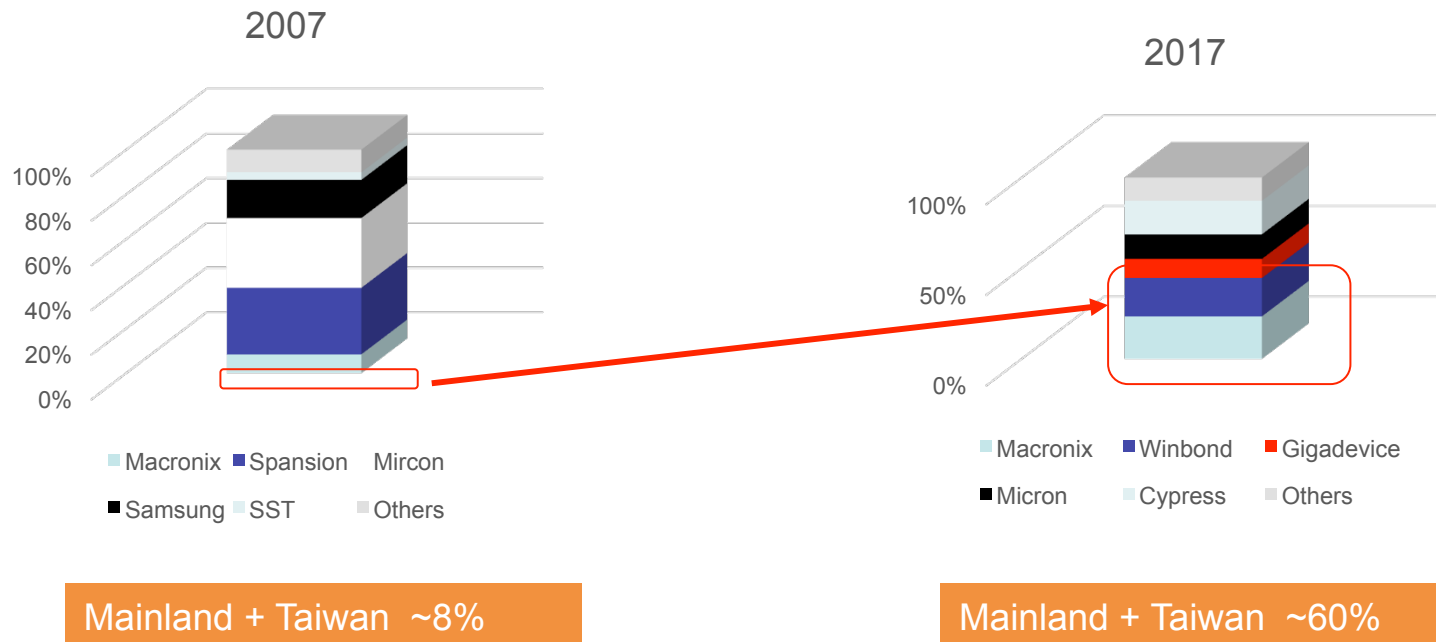



Healthy NOR Supply Chain in Greater China

Business Model	Design house	Fab/Foundry	OSAT	Programmer
Mainland	Gigadevice Dosilicon Fudan Micro ISSI	SMIC XMC HLMC	CJ TFMicro Huatian	Xelteck ZLG
Taiwan	MXIC Winbond ESMT	MXIC Winbond Powerchip	PTI ASE/SPIL	Deliprolog

NOR is currently the only self-supplied memory in Mainland China

System	Device	Core IC	Self Sufficiency
Computer System	Server	MPU	0%
	PC	MPU	0%
	Industrial	MPU	2%
General Purpose System	Programmable Logic Device	FPGA/CPLD	0%
	Digital Signal Processing	DSP	0%
Routers & Switches		Application Processor	18%
		Communication Processor	22%
		Embedded MP	0%
		Embedded DSP	0%
		Network Processor Unit	15%
Storage System	Semiconductor Memory	DRAM	0%
		NAND Flash	0%
		NOR Flash	5%
Display System	TV	Image Processor	5%
		Display Driver	0%

Memory consumption in Mainland China >\$30B USD in 2017

Mainly supplied by



New Applications Driving NOR Flash Market





Flash Memory Summit

GigaDevice Milestones

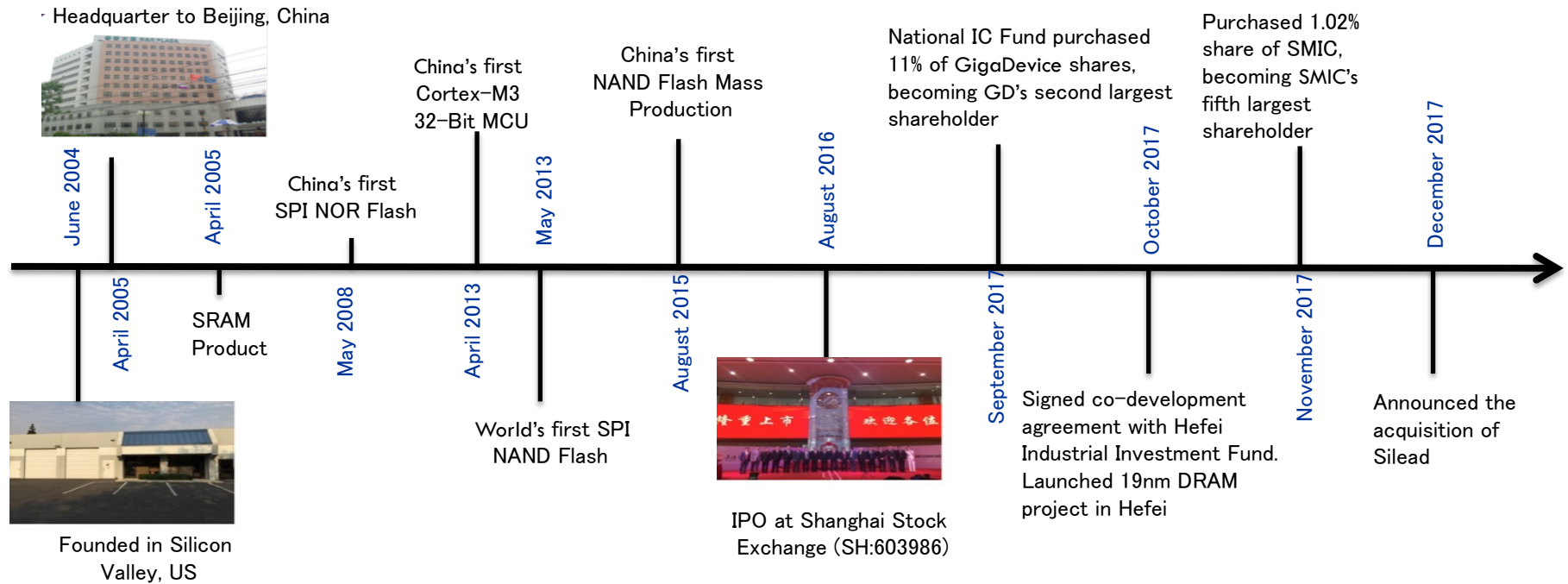

Flash Memory Summit 2018
Santa Clara, CA

Rapid Growing of GigaDevice

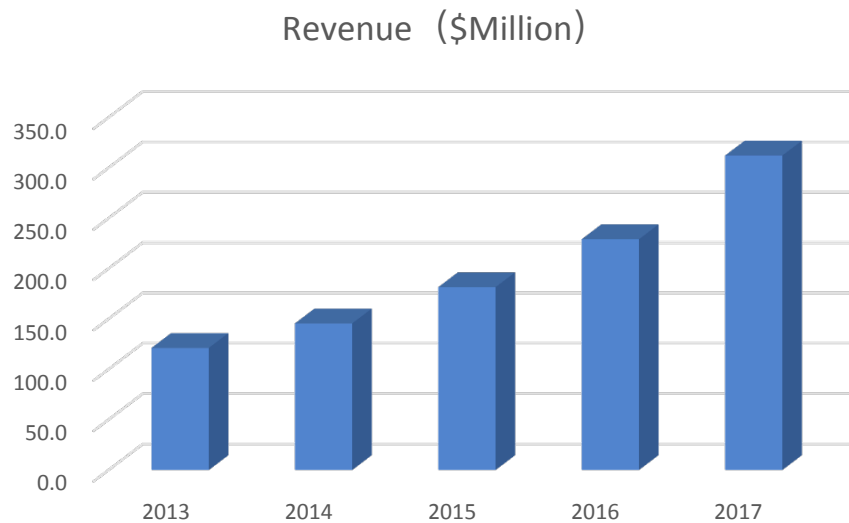

- 2017 top 10 IC design companies in China
- Top 500 listed companies in China
- Current company market value at ~USD \$5B
- Total employees: 450+, 60% in R&D, Revenue >USD \$720K per employee
- Filed 800+ patents with 323 patents granted

No. 1 NOR Flash Supplier of Mainland China

Serial NOR Flash 2017 Vendor Market Shares

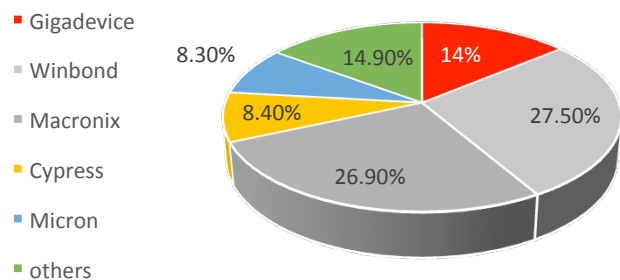

Table 2. Flash Memory 2017 Vendor Market Shares

Rank	Rank		Flash Vendor	\$ in Millions			%	Market Share		%
	2015	2016		2017	2015	2016	2017	Change	2016	2017
1	1	1	Samsung	10,080	12,180	18,047	48.2%	33.2%	33.8%	0.6
2	2	2	Toshiba	6,409	6,473	9,115	40.8%	17.7%	17.1%	(0.6)
3	3	3	WDC (SanDisk)	4,692	5,193	8,669	66.9%	14.2%	16.2%	2.1
4	4	4	Micron	4,431	4,617	6,241	35.2%	12.6%	11.7%	(0.9)
5	5	5	Hynix	3,230	3,589	5,198	44.8%	9.8%	9.7%	(0.0)
6	6	6	Intel	2,440	2,528	3,419	35.2%	6.9%	6.4%	(0.5)
8	8	7	Macronix	473	521	759	45.7%	1.4%	1.4%	0.0
7	7	8	Cypress	642	635	634	(0.1%)	1.7%	1.2%	(0.5)
9	9	9	Winbond	354	397	597	50.4%	1.1%	1.1%	0.0
10	10	10	GigaDevice	185	166	285	71.7%	0.5%	0.5%	0.1

- No. 3 SPI NOR Flash provider in the World
- The only company from Mainland China in top 10 Global Flash Memory Suppliers



Flash Memory Summit

Takeaway Messages

1. NOR was once the main Flash till feature phone years. As NAND Flash dominates in smart phone and SSD in data storage era, NOR continues to find its niche in various applications, as the indispensable code memory in every embedded system.
2. IoT, smart phone modules and automotive applications drive the NOR Flash ramping up again, both in revenue and in unit counts.
3. Suppliers from Greater China are leading the NOR Flash production and market share. GigaDevice is one of leading NOR Flash suppliers in the world and the largest NOR Flash supplier from mainland China.



Thank you