



Flash Memory Summit

New PCIe/NVMe Memory Cards Open up New High-Speed Applications

Consumer/Mobile Applications Track

CMOB-201B-1 Ballroom A

Wednesday, August 8, 2018; 9:45 – 10:50am

Chairperson: Yosi Pinto

Mobile Apps Track Organizer: John Geldman



Flash Memory Summit

New PCIe/NVMe Memory Cards Open up New High-Speed Applications - Agenda



- SD Express: Combining the Reliability of SD Cards with PCIe/NVMe – **Yosi Pinto (SDA)**
- Adaptable/Expandable External SSD-like Storage for Endpoint Products Using SD Express Cards – **Lee Prewitt (Microsoft)**
- Industrial IoT: Using SD Express Cards as Edge Storage device – **Crystal Chang (ATP)**
- Exploring New Opportunities in Client Devices Using SD Express Cards as Expandable Storage - **Jacek Wysoczynski (intel)**
- Q&A session



Flash Memory Summit



Yosi Pinto - SD Association

- Yosi Pinto is Chairman of the Board and the Technical Committee Co-Chair for the SD Association. He is also Director of Standards at Western Digital. A 30-year industry veteran, he was a major contributor to the first SD Card standard, developed the first SD card controllers, led the Memory Stick project, and was responsible for other SD/eMMC products and standards initiatives. He holds over 30 patents related to memory cards, and has organized sessions and spoken for the SD Association at previous Flash Memory Summits. He earned an MSEE from Stevens Institute of Technology (NJ) and an MBA from Tel Aviv University (Israel).



Flash Memory Summit

SD Express

Combining the Reliability of SD Cards with PCIe & NVMe

Yosi Pinto

Chairman of the Board & Technical Committee Chair in SD Association
Director of Standards at Western Digital



SDA Confidential Information and Disclaimers

Forward-Looking Statements

During our meeting today we will be making forward-looking statements.

Any statement that refers to expectations, projections or other characterizations of future events or circumstances is a forward-looking statement, including those relating to industry trends, standardization plans and any SD Association's related plans. Actual results may differ materially from those expressed in these forward-looking statements due to various factors. We undertake no obligation to realize these forward-looking statements, which speak only as of the date hereof.



Flash Memory Summit

Higher Quality Mobile Content Creates Demand for More Capacity and Greater Performance

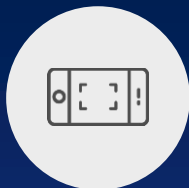

1.2 trillion photos were taken on smartphones in 2017



By 2020, over 50% of all video viewing will be on smartphones

Top 5 online streaming services Offer content download to cards for off line viewing



Continued move from Full HD > 4K+ video. A 2-hour 4K UHD movie requires 32GB storage



RAW video recording



VR & AR video increasing in quality



Flash Memory Summit

More Apps + Larger Apps = More Capacity and Greater Performance



197 Billion Apps
Downloaded in 2017

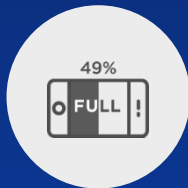

49% of smartphone users have received
a "memory full" notification



The average size
of Android™ apps
is increasing: 15MB



Apps can be stored on adopted SD card storage
in the latest Android™ devices



Client Computing, Imaging, Automotive – Transition to Higher Speed Interfaces

Flash Memory Summit

Client SSD

- PCIe and NVMe interfaces are rapidly gaining popularity - expected to become most dominant in 2018
- PCIe Gen 4 is expected to gain traction by 2019/20

Client SSD Protocol Trend

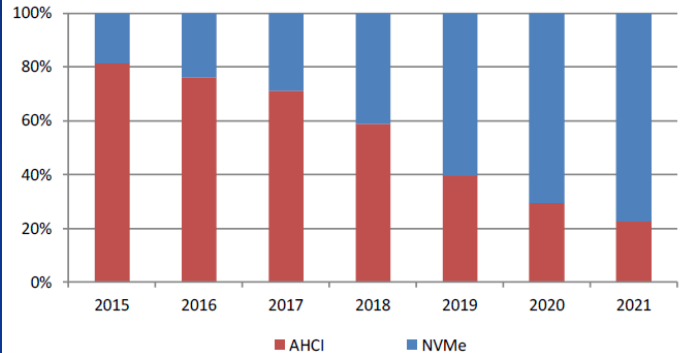

Source: Forward Insights, May 2017

New Markets Demand More Memory with Higher Speed

- Autonomous vehicles and connected cars with multi-sensor data collection & processing
- Multi-channel video capture
- Gaming with 3D high resolution graphics
- New evolving imaging market (360o, VR, AR etc...)
- Imaging market is already heading to PCIe



Evolving technology trends push memory interface requirements to higher sequential and random performance levels



Flash Memory Summit

Mobile Technology is Developing Rapidly

- Growing performance levels of IOs wireless (WiFi/WiGig...) and wired (USB3...)
- Rapid developments in APs technology (Multi cores, Speed, RAM increase etc..)
- Embedded storage is transitioning to more advanced protocols opening new opportunities (UFS, PCIe and NVMe interfaces)

Evolving technology trends push memory interface requirements to higher sequential and random performance levels

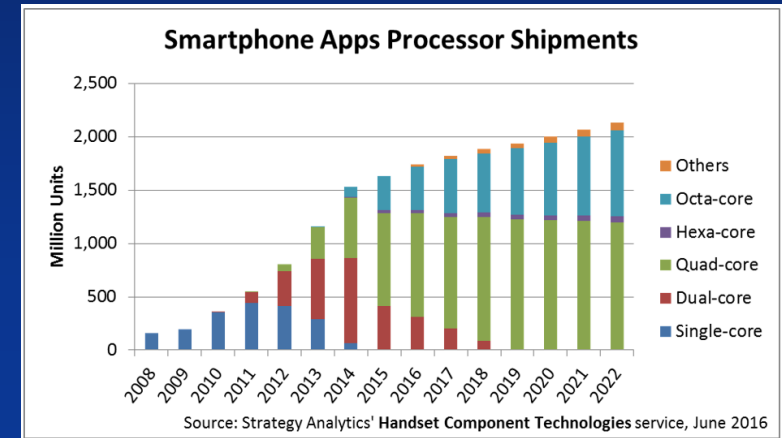
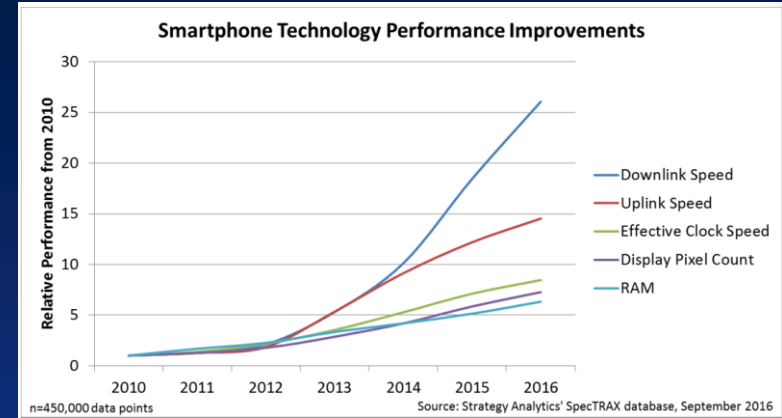



SD Express: Running Towards New Horizons

PCIe® and NVMe™ Memory Card Interfaces

- Delivers performance and advanced protocol required for the next generation of memory-intensive mobile computing applications





PCIe and NVMe Interfaces - the Future of High Performance

SD Express is the SD Card Association's Answer

Delivers sequential and random performance for next gen application platforms

Computing

8K
RAW Video and slow
motion Recording

360°
Virtual and
Augmented
Reality

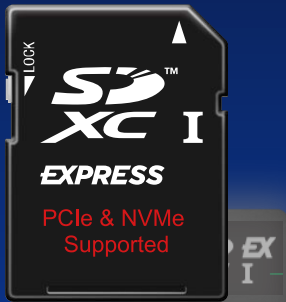

IoT
Multi
Channel
Processing

High Resolution
3D Gaming

Automotive
Multi Channel
Data Collection



SD Memory Card Standard Evolution

→ SD's New Era...

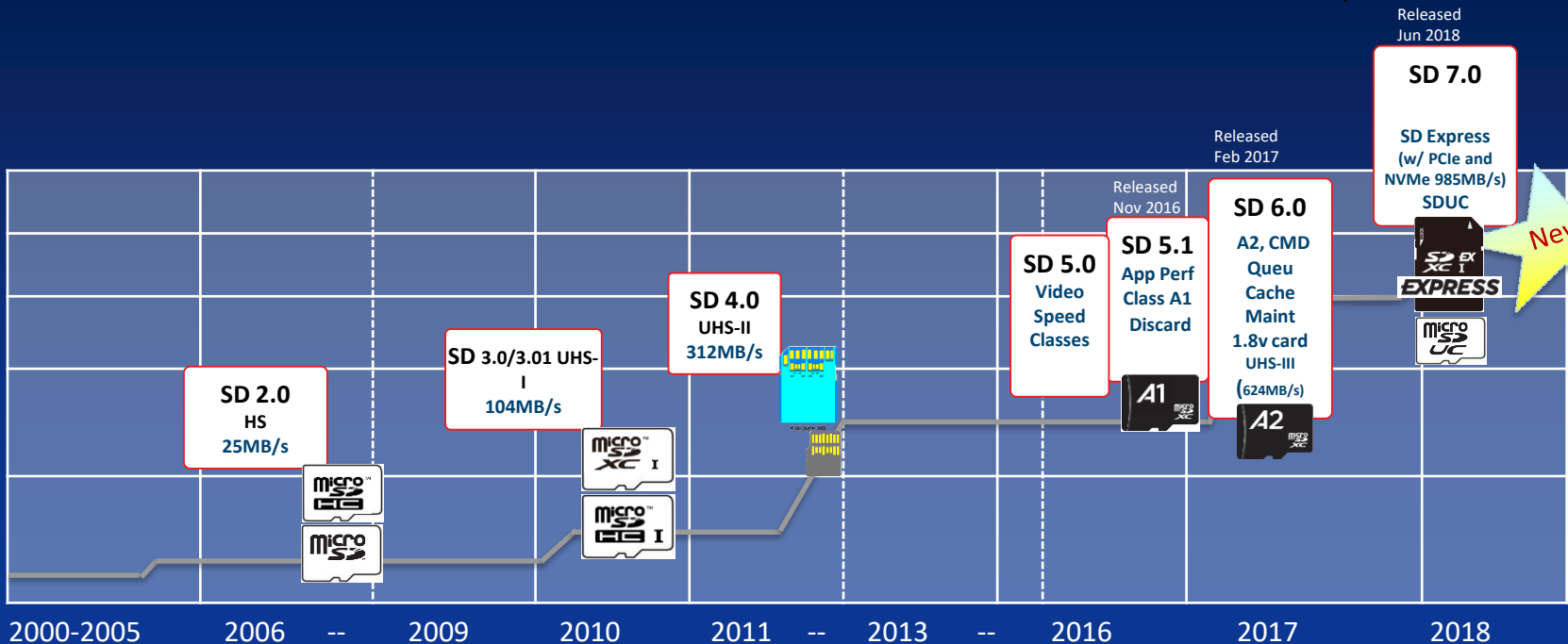



SD Express card

- Released in June 2018 as part of SD7.0
 - PCIe Gen3 and NVMe v1.3 interface added
 - Existing SD form factor
 - Legacy UHS-I interface supported allowing backward compatibility with billions of host devices
- microSD Express will hopefully follow (not announced, yet, by SDA)

EXPRESS



	UHS-I	UHS-II	UHS-III	PCIe
Bus Speed	104MB/s	312MB/s	624MB/s	985MB/s



Flash Memory Summit

Why were PCIe and NVMe
interfaces chosen?



PCIe and NVMe are widely adopted...

Flash Memory Summit

- PCIe standard developed by PCI SIG
 - Gen 3 with up to 8Gbps is a proven, reliable and mature differential interface
 - PCIe already released also Gen4 with up to 16Gbps ...and Gen 5 is underway
 - Proven environments were defined
- NVMe standard developed by NVM Express
 - The command layer protocol for Non Volatile Memories that teamed up with PCIe...
 - A scalable and sophisticated protocol – ready to handle future system needs
 - Become more and more popular as the de-facto standard for SSDs and other...
 - Supported by all major OSs
 - Proven test environments were defined



*Both are world wide recognized as the preferable protocols for future needs →
Easy to adopt !*



PCIe and NVMe Interfaces – Test Advantages

Many Bus Analyzers, Protocol Analyzers, Test Suites are in the market...

The logo for SerialTek, with 'Serial' in black and 'Tek' in red, underlined with a red swoosh.

The logo for Teledyne Technologies Incorporated, featuring a blue stylized arrow icon and the text 'TELEDYNE TECHNOLOGIES INCORPORATED'.

The logo for OakGate Technology, featuring the text 'OakGate Technology' in blue and a stylized tree icon.

The logo for Keysight Technologies, featuring a red waveform icon and the text 'KEYSIGHT TECHNOLOGIES'.

The logo for JDSU, featuring a colorful diamond icon and the text 'JDSU' in black.



PCIe and NVMe Interfaces – Product Vendor Advantages

The building blocks are available in the market

- Many SoC already implemented PCIe interfaces (for Modems, WiFi, Memory etc...) . Such PCIe interfaces exist either as:
 - Extra I/O that may be utilized for SD Express with adapter
 - Re-use of available PCIe IP building block in new SoC design
- Many standard PCIe IP modules exist in the market – supplied by the leading IP vendors

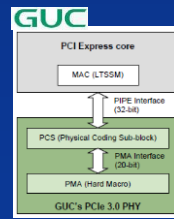
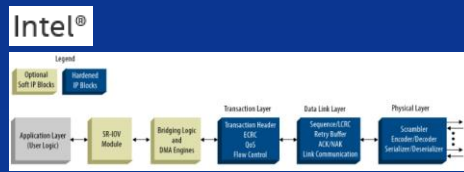
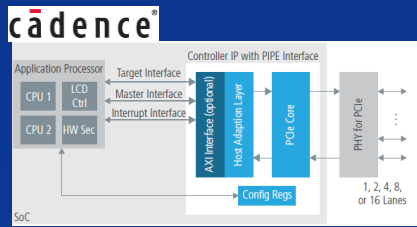
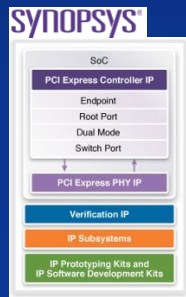
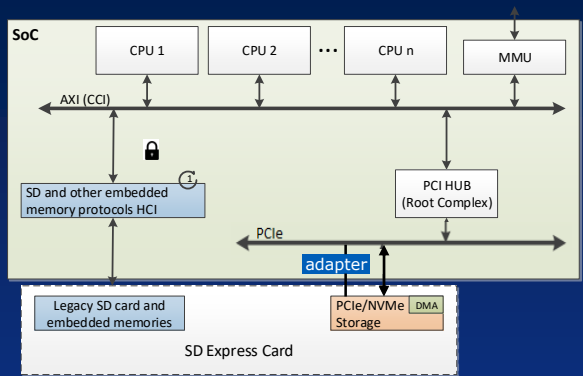



SD Express – The best of all worlds...

PCIe/NVMe like in SSD

- SSD grade performances and features
- PCIe/NVMe – a continuously innovated market-wide platform
- Scalable SW stack widely supported
- Bus mastering and reduction ram and cost
- Low power options for mobile implementations
- Leveraging existing investments for card and products manufacturers

SD Memory Card

- Most popular removable card in consumer market
- Enhanced features added: Command Queue, Cache
- SD UHS-I operation mode supported

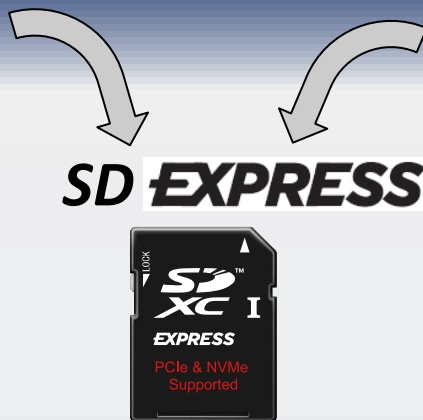

Mobile Phones

Mobile Computing

Gaming

Imaging

Automotive

IoT

....

A small SSD-Like card in reliable small SD form factor including backward compatibility with existing SD products



Flash Memory Summit

Thank You



Yosi Pinto
yosi.pinto@wdc.com



Flash Memory Summit

New PCIe/NVMe Memory Cards Open up New High-Speed Applications - Agenda

- SD Express: Combining the Reliability of SD Cards with PCIe/NVMe – Yosi Pinto (SDA)
- • Adaptable/Expandable External SSD-like Storage for Endpoint Products Using SD Express Cards – Lee Prewitt (Microsoft)
- Industrial IoT: Using SD Express Cards as Edge Storage device – Crystal Chang (ATP)
- Exploring New Opportunities in Client Devices Using SD Express Cards as Expandable Storage - Jacek Wysoczynski (intel)
- Q&A session



Flash Memory Summit



Lee Prewitt - Microsoft

- Lee Prewitt is a Principal Hardware Program Manager with 25 years of storage industry experience ranging from Magneto-Optical to spinning rust to Flash. Until recently, he worked in the Windows and Devices Group at Microsoft where he was responsible for many of the components in the storage stack including File Systems, Spaces, Storport and Microsoft's inbox miniport drivers. His responsibilities included storage devices ranging from SD and UFS in mobile to NVMe in Enterprise and Data Centers. He has recently moved to the Azure CSI team where he is responsible for Data Center storage initiatives.



Flash Memory Summit

Adaptable/Expandable External SSD-like Storage for Endpoint Products Using SD Express Cards

Lee Prewitt

Principal Hardware Program Manager

Microsoft



AAA Game Development Cost

- Development Budget: \$100M
- Marketing Budget: \$100M
- 3000-4000 people on a single title at peak
 - 80% artists, 15% managers, 5% programmers
- Artists create textures, meshes, animation data, and audio



Game Storage Requirements

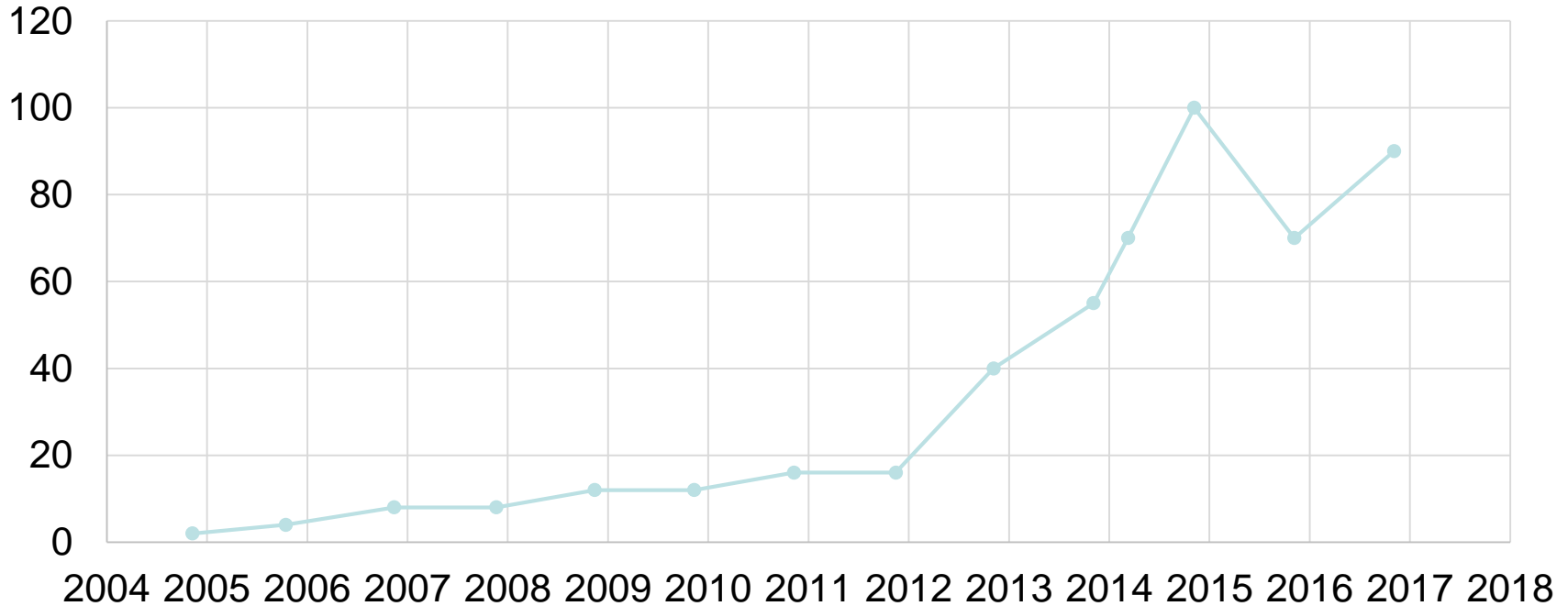



Gaming PC Market

- Gaming PCs are a growing business
- Desktop/Tower configs are high-margin but slow growth
- Gaming laptops are the top growth sector
- Most devices at gamer price points do have SSDs of some kind
- But their capacity is limited: 240GB is current sweet spot
 - But this is only sufficient to hold 2 or 3 AAA games



Key Take-Aways

- Monitors are increasing in resolution and quality (HDR)
- Game sizes are increasing too
- PC Game devices face challenges supporting this
- Dynamic loading can help significantly
- SD Cards as expandable storage can help
- SD 7.0 speeds allow game loads/game play to be done directly from the SD card



New PCIe/NVMe Memory Cards Open up New High-Speed Applications - Agenda

- SD Express: Combining the Reliability of SD Cards with PCIe/NVMe – **Yosi Pinto (SDA)**
- Adaptable/Expandable External SSD-like Storage for Endpoint Products Using SD Express Cards – **Lee Prewitt (Microsoft)**
-  • Industrial IoT: Using SD Express Cards as Edge Storage device – **Crystal Chang (ATP)**
- Exploring New Opportunities in Client Devices Using SD Express Cards as Expandable Storage - **Jacek Wysoczynski (intel)**
- Q&A session



Flash Memory Summit



Crystal Chang - ATP

- Crystal Chang, Senior Manager of Product Management at ATP Electronics, Inc.
- Crystal is in charge of the Memory card BU for ATP Electronics. During her 8 years tenure at ATP, Crystal dedicates to promoting memory cards in various industrial applications and contributing her business insight and front-end experiences to continuous product enhancement.



Flash Memory Summit



Industrial IoT era Memory cards in Edge computing

ATP Electronics, Inc.
Crystal Chang



Flash Memory Summit

Agenda



- Data Booming
- Why Edge Computing?
- When IoT go into Enterprise
- IIoT Edge Gateway Example, Function v.s. Form Factor
- SD Express: One Size Fits All?
- Take away



Data Booming



- 2021, 50 billion connected devices
- Person will use connected device 4800 times a day

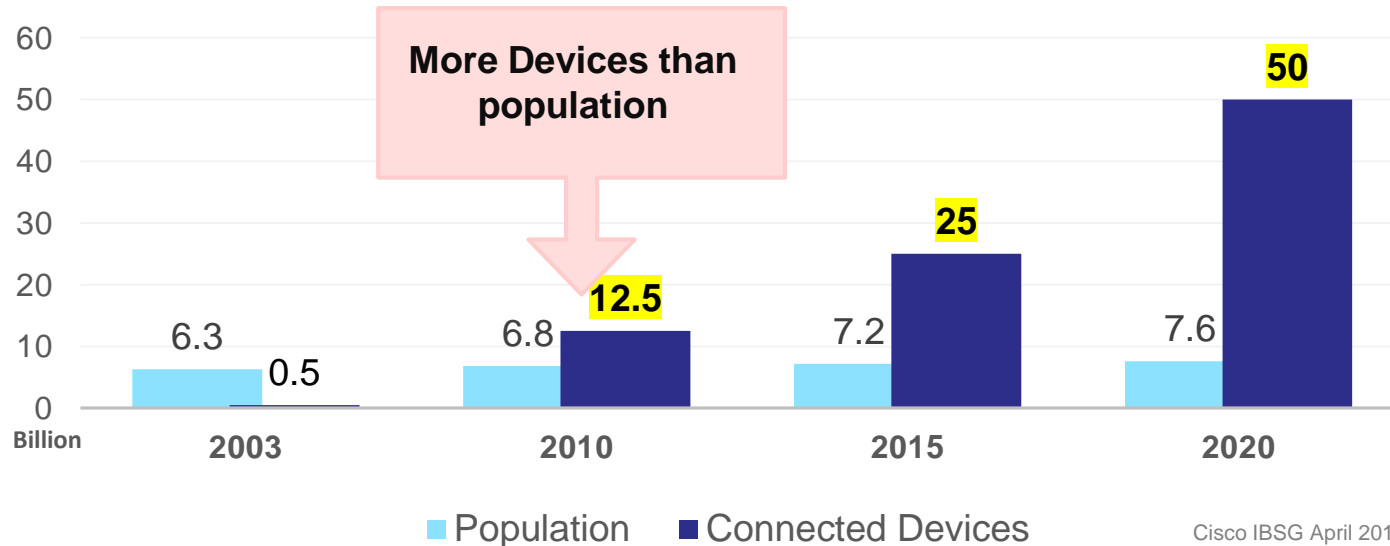



As data sharply increasing

By 2025, world data sphere expect to grow to 163 zettabytes
Massive data creation, but very little will be transmitted to Cloud.

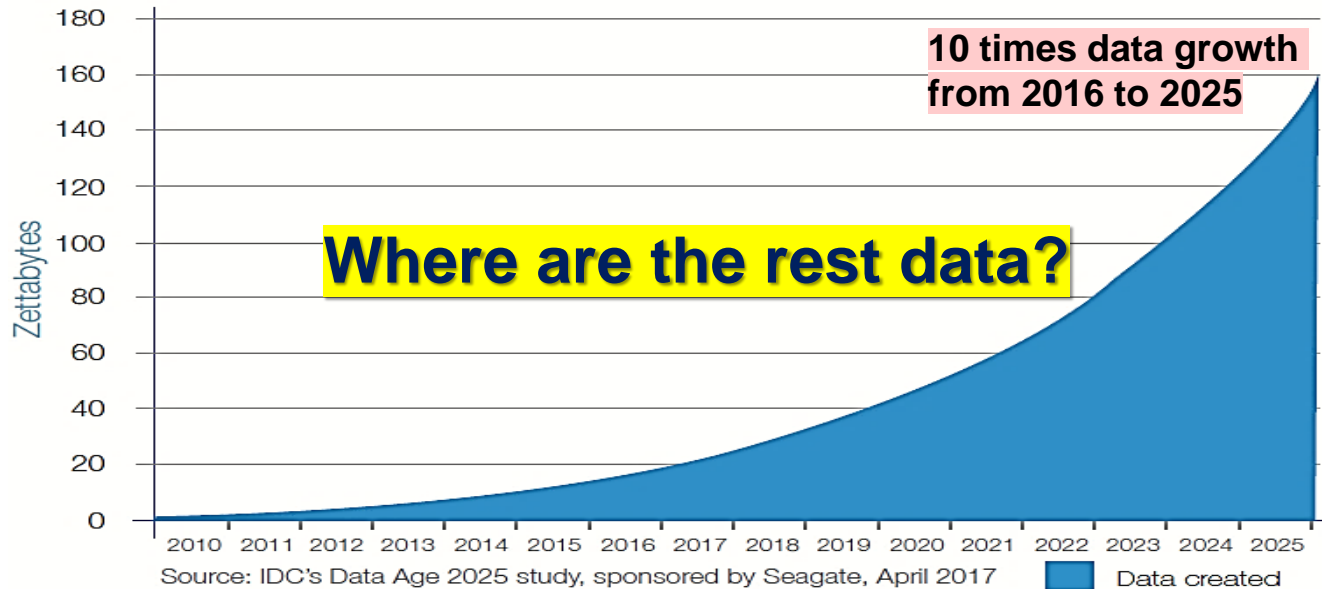

Data resource: ABI's report



Edge Computing

Edge computing was designed to fulfill the demand of latency solution

By 2020, 10% of the world's data will be processed on the Edge (IDC)

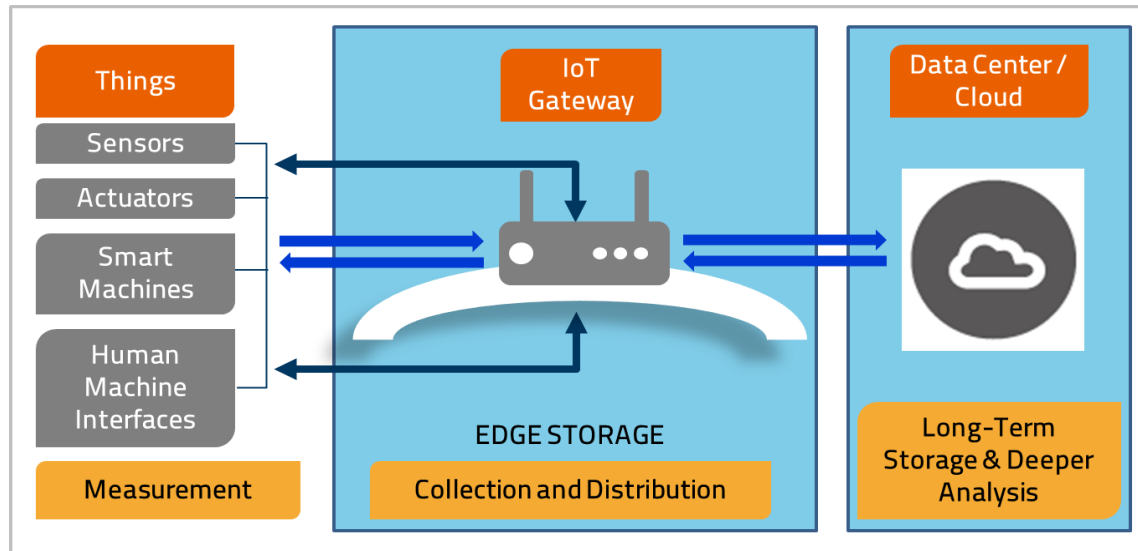



Why Edge Computing?



Cloud Storage

- **Analyze historical data** for forecasting
- **Big data** processing
- Data **warehousing**

Edge Storage

- **Real time Response**
- **At-source visualization**
- **Temporary cache** for data waiting to be transmitted to the cloud
- **Reduce network traffic** in the centralized data center



When IoT go into Enterprise



Industrial (Manuf.)

- Optimized Automation
- Manufacturing Process Control



Retail

- Digital Signage & Advertising
- Retail/Hospitality Kiosk & POS



Transportation

- Vehicles Communication
- Fleet / Traffic Control
- Logistics



Safety & Security

- Surveillance
- Disaster Management
- Emergency Service



Healthcare

- Remote Health Monitoring
- Geriatrics Care
- Tele Health



Utilities



- Smart Grid
- Water , Energy
- Waste





IloT Edge Gateway Example





Dell Gateway	3000 series(2017)	5000 series(2015)
<p>Application</p>	<ul style="list-style-type: none"> Automation Cargo Tracking/Truck/ Bus/ Train/ Marine Transportation Retail Kiosks Managing Green Energy Assets <p>(IP50 Dustproof, IEC 60068-Extreme Temp.)</p> <p><u>\$399 up</u></p> 	<ul style="list-style-type: none"> Commercial and Industrial Environments Boiler rooms or inside rooftop HVAC units. <p>(Operating temperatures from -30C to 70C, IP50, IEC 60529)</p> <p><u>\$1,260 up</u></p> 



Edge Gateway: Function V.S Storage

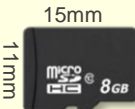
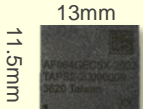
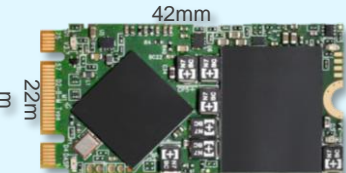

Type	3000 series 	5000 series 
Dimensions	125mm wide x125mm high x51mm deep	229mm wide x216mm high x75mm deep
Storage/ Drives	microSD: 8GB~64GB eMMC: 8 GB / 32 GB  	SSD M.2: 32GB~512GB. 
Features	<ul style="list-style-type: none"> Limited space, Mobile, Localized Robustness Basic edge analytics 	<ul style="list-style-type: none"> Fixed use cases for modular expansion Large sensor network Advanced edge analytics

1/2
Size

1/3
Size



SD Express: One Size Fits All?

- **Small Form Factor**
- Popular extension form factor in many IoT devices
- **Removable**
- **Low power consumption**
- Robust (IP57/67) waterproof, dustproof



- **Low Latency**
- **Faster performance**
PCIe-G3
- As host memory buffer
- Bus mastering
- Multi Queue support in DRAM



SD Express for various gateway needs
Powerful, small form factor, flexible for storage “expansion” (removable)



Take Away

SD Express – Powerful, Bite size, Removable SSD

- **SD Express** with *PCIe/NVMe* interface
- Integrate all the benefits of PCIe/NVMe with existing SD form factor
- Suitable for *Multi-Channel Edge Computing* – collect massive data from sensors, process & analyze data for *Real Time Response* requiring *High Bandwidth, Low Latency*
- Powerful yet *Low Power Consumption*
- *Removable, Bite Size and Robust* – fit into limited edge device space running at harsh environment
- Backward compatible: select legacy SD or SD express ¹

Note 1: For more information, please refer to SDA white paper: SD Express Cards with PCIe and NVMe Interfaces



Flash Memory Summit

A graphic of a 3D NAND memory stack, showing multiple layers of blue and white rectangular blocks stacked on top of each other, with a glowing blue base. The text '3D NAND' is overlaid on the stack.

3D NAND
For Industrial, Embedded
Applications

Visit ATP Electronics Meeting Room 205

Reserve your meeting with ATP

2018 Flash Memory Summit August 7th ~9th





New PCIe/NVMe Memory Cards Open up New High-Speed Applications - Agenda

- SD Express: Combining the Reliability of SD Cards with PCIe/NVMe – **Yosi Pinto (SDA)**
- Adaptable/Expandable External SSD-like Storage for Endpoint Products Using SD Express Cards – **Lee Prewitt (Microsoft)**
- Industrial IoT: Using SD Express Cards as Edge Storage device – **Crystal Chang (ATP)**
- ➔ • Exploring New Opportunities in Client Devices Using SD Express Cards as Expandable Storage - **Jacek Wysoczynski (intel)**
- Q&A session



Flash Memory Summit



Jacek Wysoczynski - Intel

- Jacek Wysoczynski is holding Strategic Planner position in Non-volatile Memory Solutions Group at Intel Corporation. He is responsible for defining the storage software strategy and long-range roadmap for Client platforms, including Intel® Rapid Storage Technology and Intel® Optane™ Memory solutions. During his 20+ years of working for Intel he contributed into numerous products from multiple domains including storage, embedded, networking, telecommunication, operating systems, and distributed services. Now he focuses on innovation and usages related to PCIe/NVMe storage and memory with strong emphasis on the system/software aspect of it. Jacek holds patents and publications in wireless technology field. Mr. Wysoczynski received his MSc degree from Technical University of Gdansk



Flash Memory Summit

Client Platform Evolution Using Expandable Storage

Jacek Wysoczynski

Non-Volatile Memory Solutions Group, Intel Corporation



Today's Problems with Removable Cards

Flash Memory Summit



Slow and Inefficient



Multiple Protocols with
Different Drivers



Extra Cost to Use
in PC



Usages Limited to
Removable Storage



Solving Issues with SD Express



Performance



SD Express Cards with PCIe* NVMe Interface



Direct Connect to Lower BOM

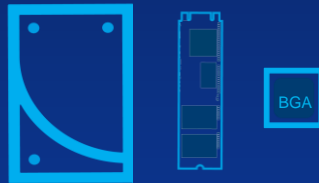

Leveraging the NVMe* SSD Ecosystem



Scalable PCIe* Interface

Solving these problems creates new usage possibilities!



Expandable Storage: The Future?

Flash Memory Summit

THE FUTURE OF CLIENT STORAGE & MEMORY

Higher Performance, Lower Cost, Easier Migration

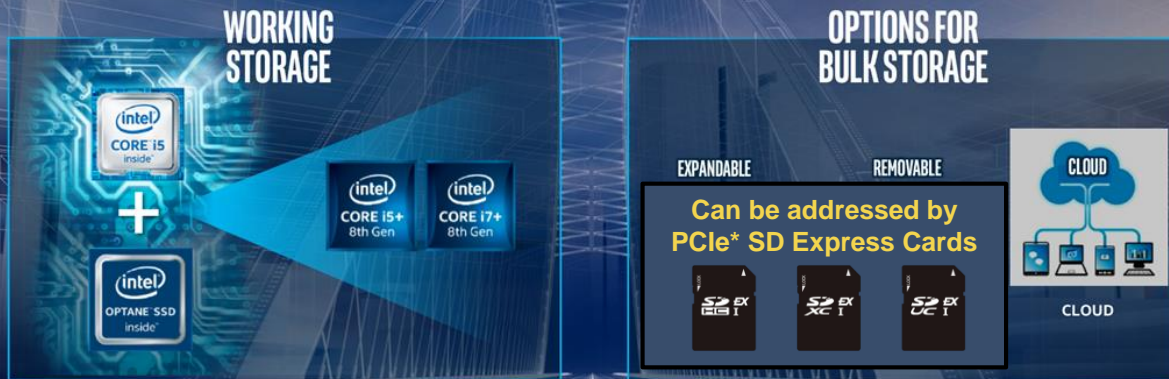

Uncompromised storage performance with flexibility at cost!



Flash Memory Summit

SD Express Expands Possibilities

SD Express Propels SD Cards Forward Without Losing What Makes It Great

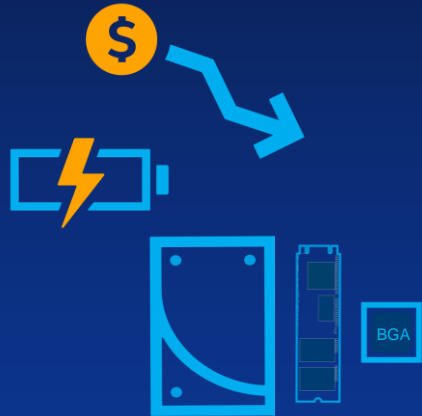

Consider new possibilities for using SD Express!



Flash Memory Summit

Thank You!



Flash Memory Summit

New PCIe/NVMe Memory Cards Open up New High-Speed Applications - Agenda

- SD Express: Combining the Reliability of SD Cards with PCIe/NVMe – **Yosi Pinto (SDA)**
- Adaptable/Expandable External SSD-like Storage for Endpoint Products Using SD Express Cards – **Lee Prewitt (Microsoft)**
- Industrial IoT: Using SD Express Cards as Edge Storage device – **Crystal Chang (ATP)**
- Exploring New Opportunities in Client Devices Using SD Express Cards as Expandable Storage - **Jacek Wysoczynski (intel)**
- Q&A session

